

M-Bus Master MultiPort 250D

Installation and User Guide



Kamstrup A/S
Industrivej 28, Stilling, DK-8660 Skanderborg
Tel: +45 89 93 10 00 · Fax: +45 89 93 10 01
info@kamstrup.com · www.kamstrup.com

Contents

1	Introduction	4			
1.1	Design	4	4.3.1	<i>Cable</i>	17
			4.3.2	<i>Cable topology</i>	18
			4.3.3	<i>Examples of network sizes</i>	21
2	Functionality	5			
2.1	Overview of functions	7	5	M-Bus Addressing	22
			5.1	Primary addressing	22
			5.2	Secondary addressing	22
			5.3	Enhanced secondary addressing	22
3	Connections	8			
3.1	Overview of connections	9	6	M-Bus communication	22
3.2	Power supply	10	6.1	Communication speed	22
3.3	USB	10	6.2	Transparent reading	23
3.4	RS-232	13			
3.5	RS-485	14	7	Operation of	
3.6	Optical eye	14		M-Bus Master MultiPort 250D	23
3.7	M-Bus Output	14	7.1	Keys	24
3.7.1	<i>Current and voltage</i>	14	7.2	Light Emitting Diodes	24
3.8	M-Bus Repeater Input	15	7.2.1	<i>Power</i>	25
			7.2.2	<i>Request</i>	25
			7.2.3	<i>Data</i>	25
			7.2.4	<i>Overload</i>	25
4	Cabling	16	7.3	Display	25
4.1	Special features of M-Bus Master MultiPort 250D	16	7.4	Menu overview	26
4.2	Electrical conditions in an M-Bus network	17	7.5	Meter search by means of MultiPort 250D	26
4.2.1	<i>M-Bus modules</i>	17			
4.3	Installation parameters	17			

7.5.1	Primary scanning	27	8	Web Server	37
7.5.2	Secondary scanning	28	8.1	IP->COM program	37
7.6	Meter reading by means of MultiPort 250D	29	8.1.1	Configuration of IP->COM	39
7.6.1	Meter reading after scanning	29	8.2	Main menu	42
7.6.2	Meter reading from the menu Read Meter	29	8.3	Status menu	44
7.7	Settings of MultiPort 250D	30	8.4	Settings	45
7.7.1	Date and time	30	8.5	Remote control	46
7.7.2	Contrast	30	8.6	Event loggers	47
7.7.3	M-Bus	30	8.7	Power statistics	48
7.8	Green Mode	32	8.8	About M-Bus Master MultiPort 250D	49
7.9	Other settings	32	9	GSM/GPRS	50
7.10	PIN code	33	10	Dimensioned drawings	51
7.11	Advanced	33	11	Technical data	52
7.11.1	Reading a specific meter via the M-Bus address	34	12	Ordering numbers	53
7.11.2	Reading a meter via secondary address	34			
7.11.3	Display latest meter reading	34			
7.11.4	Network troubleshooting	34			
7.11.5	Information loggers	35			
7.11.6	Factory settings	36			
7.11.7	Communication Test	36			
7.11.8	Bus Info	36			
7.11.9	Restart master	37			
7.11.10	About M-Bus Master MultiPort 250D	37			

1 Introduction

M-Bus is a bus system, which is specially suited for reading of water, heat, cooling, gas and electricity consumption meters. An M-Bus system consists of an M-Bus Master and a number of meters with M-Bus interface. A network can include different meter types and brands. The cable type used will typically be twisted pair copper.

The connected meters are read either directly by the master with data appearing on the master's display, or by a reading program which is connected to one of the master's communication ports.

The master powers the M-Bus slave modules in the meters. Battery supplied meters thereby achieve a longer battery lifetime.

The maximum size of an M-Bus network using Kamstrup M-Bus Master MultiPort 250D is 250 meters. If a number of masters are configured as repeaters and coupled in cascade and only secondary addressing is used, a total of 1,250 meters can be connected, and the total cable length can be up to approx. 14 km.

If primary addressing is used, up to 250 meters can be connected.

Communication in the M-Bus network is asynchronous serial bit transmission in half duplex, which means that it is only possible to communicate in one direction at a time.

Communication speed can be 300, 2400 or 9600 Baud.

It is not necessary to connect a PC to the master during installation, maintenance and troubleshooting in the M-Bus network as the master itself includes the functions needed. Operation is carried out via display and front keys.

M-Bus is standardized according to EN 13757-2 and EN 13757-3.

1.1 Design

M-Bus Master MultiPort 250D is built into a solid cabinet, which complies with protection class IP 67.

The front consists of a backlit LCD, 6 keys, 4 status LEDs and an optical eye.

The power supply is a switch mode type which enables you to connect the master to a power supply between 100 and 240 Volt. The frequency must be 50-60 Hz.

2 Functionality

Kamstrup M-Bus Master MultiPort 250D is an M-Bus master designed for the connection of up to 250 meters with M-Bus interface. The cable length of a master can be up to 2800 m depending on cable type.

The master supports primary, secondary and enhanced secondary addressing. Enhanced secondary addressing is supported when the Master is used as level converter, not when reading via the display.

All inputs are galvanically separated from the M-Bus network.

Designing the master it has been considered important that installation and analysis work can be effected direct from the master without having to connect a PC with dedicated software.

Configured as master, MultiPort 250D is operated via its display and the six front keys.

The display has been designed with a user-friendly menu structure, which makes it simple to perform scanning, reading and analysis of the M-Bus network. Furthermore, the display currently provides information on network status such as current communication and number of connected meters (Unit Loads).

Configured as level converter one or several of the integrated communication ports are connected to a reading system, a control unit or similar. Communication is controlled from the connected units.

MultiPort 250D can be accessed from all available communication ports. The integral port controller prevents collision in case of simultaneous communication through more than one port.

When the port controller detects communication on one port, communication on other ports becomes impossible. When communication on one port is finished, all ports are open to communication.

The Repeater function makes it possible to extend the size of the M-Bus network both as to number of meters and total cable length. If one master and four repeaters are installed in a network, the total cable length can be extended to approx. 14 km and up to 1250 meters can be connected.

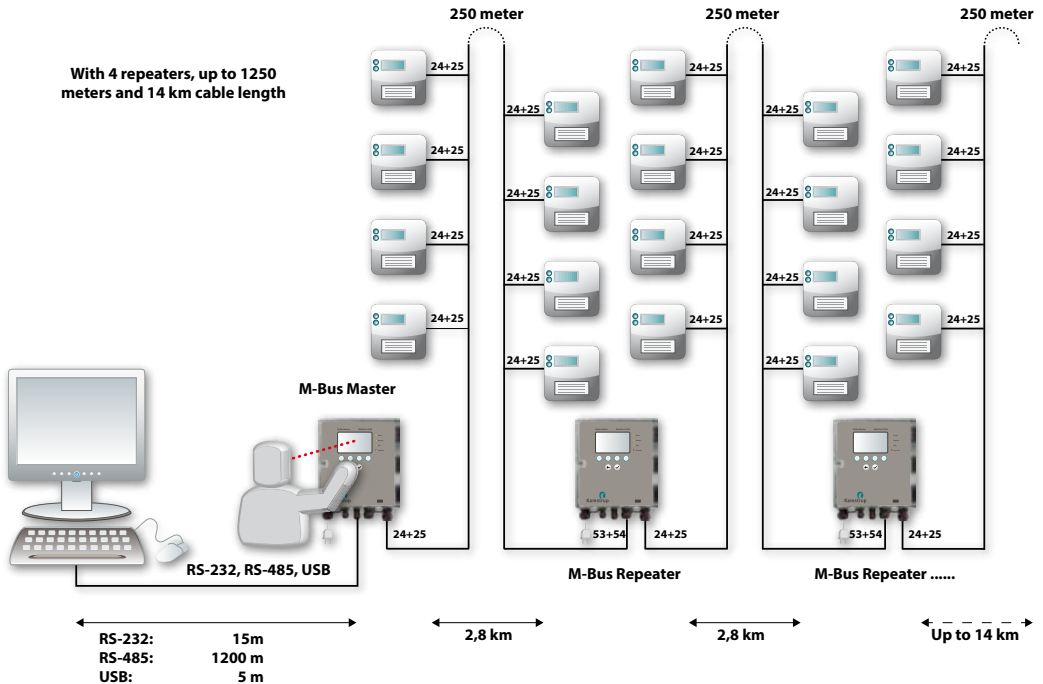

The master's module area provides extra communication options, e.g. GSM/GPRS, and also prepares the master for additional future functionalities.

The integrated web server enables remote operation of the master as to configuration, scanning and reading via RS-232, RS-485 and USB.

Operation via keys and communication through the optical eye can be protected by a PIN code.

Four light emitting diodes indicate the status of mains supply, data communication as well as possible overload and short-circuit of the M-Bus network.

Kamstrup M-Bus Master MultiPort 250D has been designed for installation indoors. The protection class can be up to IP 67.

2.1 Overview of functions

- Usable as master, repeater and level converter
- Backlit 128 x 64 pixels LCD
- Reading via display of both Kamstrup meters and foreign brands
- Supports primary, secondary and enhanced secondary addressing
- Collision detection with break signal
- Up to 250 slaves per master
- Integrated repeater function
- Up to four repeaters in a system = a total of 1250 meters
- Up to 14 km cable length
- 300, 2400, and 9600 baud communication speed
- Byte recovery
- Echo suppression
- Transient protection
- Integrated USB, RS-232, RS-485 and optical eye with automatic port controller
- Module area for e.g. GSM/GPRS module
- All ports are transparent and galvanically separated from the M-Bus network
- Integrated web server for remote configuration, analysis and reading
- PIN code protection of keyboard and optical eye
- Event loggers for M-Bus master and M-Bus network
- Cable connection via 9 PG cable glands
- Local and remote update of firmware for future functionality
- Up to IP 67 protection class.

3 Connections

All connections in MultiPort 250D are screw terminals with max. cable size of 2 mm².

The protection class of M-Bus Master MultiPort 250D can be up to IP 67. IP 67 means full dust protection as well as water tightness for minimum 30 minutes down to 1 metre.

In order to obtain the highest IP protection the cables used must be correctly mounted through the master's unions.

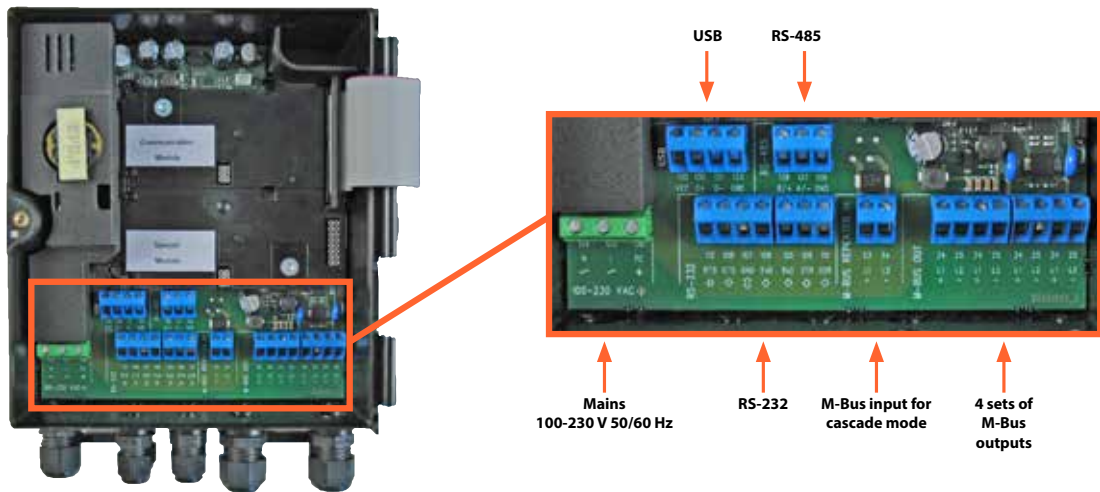

3.1 Overview of connections

Connection number on master	Designation	Colour/connector No.	Description
Power supply			
134	N	Blue	Neutral
135	L	Brown	Live
136	PE	Yellow/green	Protective earth
USB 2.0			
			Max. recommended cable length: 5 m
130	VCC	Red/1	5 V power supply
131	D-	White/2	Data -
132	D+	Green/3	Data +
133	GND	Black/4	Ground
RS-232			
			Max. recommended cable length: 15 m
105	RxD	2	Received Data
106	TxD	3	Transmitted Data
107	GND	5	Ground
108	DTR	4	Data Terminal Ready
109	CTS	8	Clear To Send
111	DSR	6	Data Set Ready
112	RTS	7	Request To Send
RS-485			
			Max. recommended cable length: 1,200 m
137	A/-		Transmit/Receive inverted
138	A+		Transmit/Receive non-inverted
139	GND		Ground
M-Bus Repeater Input			
			Jumper must be set to Repeater
53	L1		M-Bus input to master in repeater mode
54	L2		M-Bus input to master in repeater mode
M-Bus Master Output			
			4 sets connection terminals, connection in parallel
24	L1		M-Bus output from master to meters
25	L2		M-Bus output from master to meters

3.2 Power supply

The power supply of M-Bus Master MultiPort 250D is the switch mode type which requires voltage between 100 V and 240 V. The frequency can be 50 Hz or 60 Hz.

The mains cable is connected to the master through the associated gland. The diameter must be between 4 and 8 mm.

The master is supplied without mains cable and we recommend a fixed installation, i.e. without using a mains plug as this would reduce reliability of operation.

3.3 USB

M-Bus Master MultiPort 250D's USB-connection can be used for M-Bus communication on an equal basis with the other serial connections.

The following communication speeds can be used for M-Bus communication:

- 300 Baud 8E1
- 2400 Baud 8E1
- 9600 Baud 8E1

USB version 2.0, which allows up to 5 m cable length, is used. In connection with other USB versions than 2.0 the maximum cable length recommended is 3 m.

The master's integrated port controller makes sure that communication is only possible on one serial port at a time.

The master is available with a factory-mounted 145 cm cable fitted with a USB connector type A.



USB connector type A

To be able to communicate with M-Bus Master MultiPort 250D via USB the corresponding USB driver must be installed on the computer used for reading.

The program is available on Kamstrup's home page.

Home Kamstrup world wide Local services **SMART OBJECTS 2010**



Kamstrup
- metering solutions

www.thegreendifference.info

Products & solutions Kamstrup AMR systems Case stories About us Press Room Events & exhibitions Contact us Online services

Contact Kamstrup

Kamstrup A/S
Industrivej 28, Skilling
DK-8500 Silkeborg
Teli: (+45) 88 92 32 00
Faksi: (+45) 88 92 32 01
info@kamstrup.dk

Kamstrup world wide



Quickguide to products

- Meters
- Gas products
- Water heating
- Product behavior
- Operation
- Test & Configuration

Here you will quickly and easily find documentation on Kamstrup's products and services.

Are you new to our homepage or would you like further information on our product range, or recommend pages click "Products" in the main menu.



Open standard

New



BTU Meter reading with wireless M-Bus

Simple and easy wireless reading of heat meters and cooling meters.

- System setup in 15 minutes
- Readout time per meter: 3-2 seconds

The wireless M-Bus system from Kamstrup reads the combined heat and cooling meter MULTICAL 402.

Wireless M-Bus Reader
MULTICAL 402 - BTU meter

Kamstrup AMR systems



Kamstrup AMR - solutions for automatic reading, managing and billing of consumption data.

AMR solutions are easy to use, reliable and profitable and can be scaled and adjusted to match your requirements for functionality.

With a Kamstrup AMR system you always get a complete solution. Constructed according to your needs and adapted to your operation and business. Sourced, installed and put into operation by one supplier.

Read more...

District Heating Funnels



Mobile Heat Meter Readout - by Garbage Van

50,000 heat meters are connected in a mobile radio network in Odense, Denmark. The meters are being read automatically and wirelessly when the garbage is being collected. All data for billing and grid optimization are delivered on time, and what's more: the utility saves money and manpower.

Read the full story...

Online services



On our website you can place orders, get web support for your DC programs and download documentation 24 hours/day.

- System support
- Downloads
- Utilities
- USB Meter Reader Software
- Wireless M-Bus Reader Software

When selecting Run, the installation program starts automatically.
When the program is retrieved, it is saved under C:\Kamstrup\M-Bus Master 250D.

Select as shown below in order to install the program.

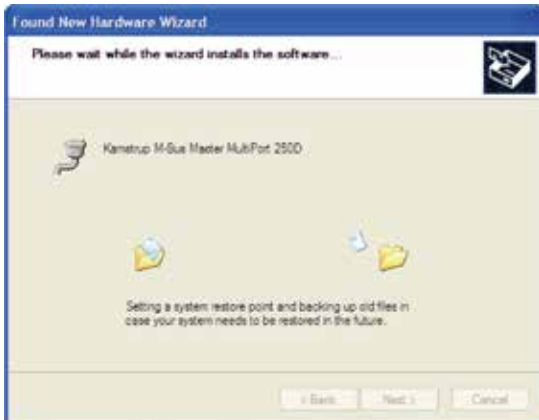
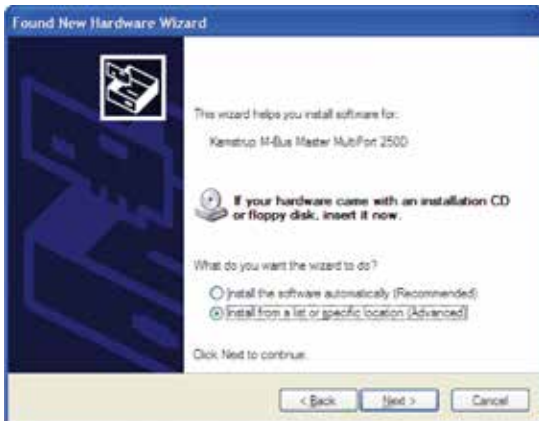



3.4 RS-232

M-Bus Master MultiPort 250D's RS-232-connection can be used for M-Bus communication on an equal basis with the other serial connections.

The following communication speeds can be used for M-Bus communication:

- 300 Baud 8E1
- 2400 Baud 8E1
- 9600 Baud 8E1

Maximum recommended cable length is 15 m.

The master's integrated port controller makes sure that communication is only possible on one serial port at a time.

The master is available with a factory-mounted 145 cm RS-232 cable fitted with a DB9F female connector.

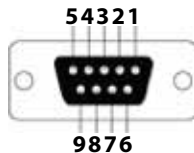

RS-232 connector type DB9F

3.5 RS-485

M-Bus Master MultiPort 250D's RS-485-connection can be used for M-Bus communication on an equal basis with the other serial connections.

The following communication speeds can be used for M-Bus communication:

- 300 Baud 8E1
- 2400 Baud 8E1
- 9600 Baud 8E1

Maximum recommended cable length is 1,200 m.

The master's integrated port controller makes sure that communication is only possible on one serial port at a time.

3.6 Optical eye

M-Bus Master MultiPort 250D's optical eye can be used for M-Bus communication on an equal basis with the other serial connections.

The following communication speeds can be used for M-Bus communication:

- 300 Baud 8E1
- 2400 Baud 8E1
- 9600 Baud 8E1

The master's integrated port controller makes sure that communication is only possible on one serial port at a time.

3.7 M-Bus Output

All meters in an M-Bus network are connected to M-Bus Output terminals 24 and 25. The master includes four sets of connections coupled in parallel.

3.7.1 Current and voltage

Bus mark/space	41 V DC/28 V DC	
Detection level, communication	7 mA	
Detection level, collision	25 mA	
Max. normal operating current	375 mA	
Warning level, operating current	377 mA	- Overload LED flashes
Overload level, operating current	500 mA	- Overload LED is constantly illuminated

3.8 M-Bus Repeater Input

Kamstrup M-Bus Master MultiPort 250D can be used as both master and repeater. Used as master, up to 250 meters can be connected in an M-Bus system.

The Repeater function makes it possible to extend the size of the M-Bus network both as to number of meters and total cable length. If one master and four repeaters are installed in a network, the total cable length can be extended to approx. 14 km, and up to 1250 meters can be connected.

The master is configured as repeater by placing the jumper on the connector marked Repeater. Using an M-Bus Master MultiPort 250D as a repeater the M-Bus network in front of the repeater is connected to "M-Bus Repeater In" on terminals 53 and 54. The following meters are connected to M-Bus Out on terminals 24 and 25.



Position of master/repeater jumper

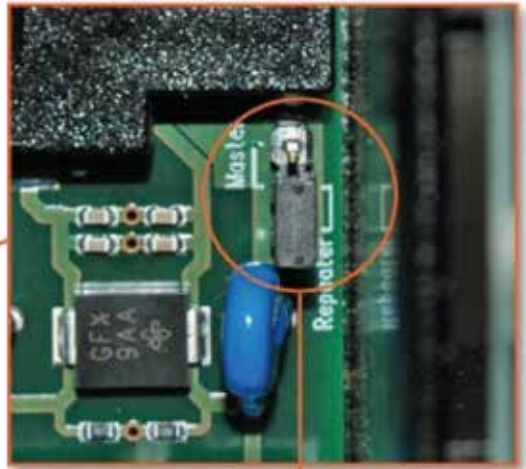

Setting as master or repeater

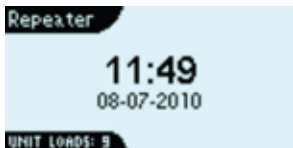

250D configured as repeater

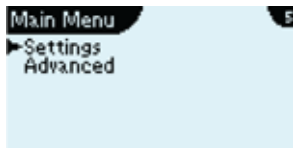

Main menu, when 250D is configured as repeater

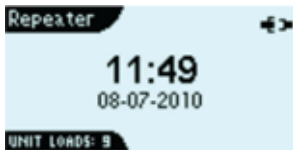

If the repeater is not connected to a master or repeater via terminals 53 and 54, the symbol shown in the top right-hand corner is displayed.

Note: The power supply *MUST* be switched off during reconfiguration between master and repeater.

4 Cabling

Typically unshielded twisted pair cable up to approx. 1.5 mm² is used. The cabling topology is typically star or bus or a combination of both. The connection in M-Bus is independent of polarity and no termination resistance at the end of the cabling is needed.

If a cable type with shield is used, it is important that the two M-Bus conductors are not connected to ground or shield.

No precise indication as to maximum cable length in an M-Bus network can be given as it depends on various parameters.

The two most important parameters to consider when selecting cable for an M-Bus installation are cable resistance and cable capacity. Generally speaking the resistance limits the number of M-Bus slaves, and the capacity limits the communication speed.

Furthermore, we recommend keeping a certain distance between M-Bus cables and other cables in order to minimize noise from high-power electric machinery.

4.1 Special features of M-Bus Master MultiPort 250D

M-Bus Master MultiPort 250D has been designed with the newest cable driver technology, and is, therefore, rather insensitive to the capacity of the M-Bus network.

Thus, designing an M-Bus network to be used together with M-Bus Master MultiPort 250D the limiting factor as to possible cable length will primarily be the cable resistance in the network.

4.2 Electrical conditions in an M-Bus network

According to EN 13757-2, the maximum output voltage from an M-Bus Master must not exceed 42 V. The output voltage from M-Bus Master MultiPort 250D is 41 V.

- If the voltage measured over terminals 24-25 is 24 V or more at the most distant meter, there is a high degree of certainty that all meters can be read
- If the voltage is between 20 and 24 V, it will probably be possible to read all meters
- If the voltage is between 18 and 20 V, the meter may be read
- If the voltage is below 18 V it is most likely that the meter cannot be read

There must be no communication on the M-Bus network when the above measurement is made.

4.2.1 M-Bus modules

Each M-Bus module loads the M-Bus network too. According to the standard, an M-Bus module should load the network with 1 unit load (UL) corresponding to 1.5 mA. Some modules, however, load with up to 4 UL.

Capacitively the load of an M-Bus module is 0.5 – 1 nF.

The number of connected M-Bus slaves is shown on the display of M-Bus Master 250D. Please note that it is not possible to show the exact number of connected slaves. This is due to tolerances in the slaves.

4.3 Installation parameters

The following parameters are essential to the possible cable length of an M-Bus network.

4.3.1 Cable

The cable resistance and capacity must be as low as possible. The thicker the cable, the lower the resistance. The thicker the cable, the higher the capacity.

An M-Bus cable must minimum be able to handle 50 V and 500 mA.

Diameter (mm ø)	Cross section (mm ²)	Resistance in Ohm per 1,000 metres	Length in metres per Ohm
0.5	0.20	90	11
0.65	0.33	53	19
0.8	0.50	35	29
1.0	0.79	23	45
1.13	1.00	18	57
1.26	1.25	14	71
1.39	1.52	12	87
1.6	2.0	8.7	115

Examples of resistance in copper cable

Please note that the resistance in copper depends on its purity. The purer the copper, the lower its resistance.

LiYY	2x0.34 mm ²	2x0.50 mm ²	2x0.75 mm ²	2x1.0 mm ²	2x1.5 mm ²
Current load	Max. 4.5 A	Max. 6 A	Max. 10 A	Max. 12 A	Max. 18 A
Cable resistance	56 Ω/km	39 Ω/km	26 Ω/km	20 Ω/km	12 Ω/km
Capacity	110 nF/km	120 nF/km	120 nF/km	120 nF/km	120 nF/km

J-Y(St)YY		2x0.60 mm ²	2x0.80 mm ²		
Current load		-	-		
Cable resistance		65 Ω/km	37 Ω/km		
Capacity		120 nF/km	100 nF/km		

Examples of cable types

In big networks using secondary addressing worst case load must be considered as 250 slaves of 1 UL (Unit Load) each can draw 5.4 A, which thin cables will not be able to withstand.

Please note that resistance can be stated in two different ways in cable specifications; i.e. as cable resistance or as loop resistance.

Loop resistance is the total resistance measured through the two conductors. Cable resistance is the resistance through one conductor. Therefore, loop resistance is always twice the cable resistance.



Measurement of loop resistance



Measurement of cable resistance

4.3.2 Cable topology

An M-Bus network normally uses bus or star topology, or a combination of both.

The advantage of bus topology is shorter wires. The disadvantage is that a cable interrupt will mean that all the following meters can no longer be read.

The advantage of star topology is the fact that all the other meters can still be read after a cable interrupt. The disadvantage is a large consumption of cable with a high leading load, which reduces the maximum cable length and makes a reduction of communication speed necessary respectively.

Bus topology offers two solutions, one looping the cable through each meter. This solution presupposes that there is room for two cables and that the connection terminals are prepared for the connection of two sets of cables. All connections are thereby typically made inside the meter.

Using bus topology with each individual meter connected to the bus, a number of connections must be established on the bus itself.

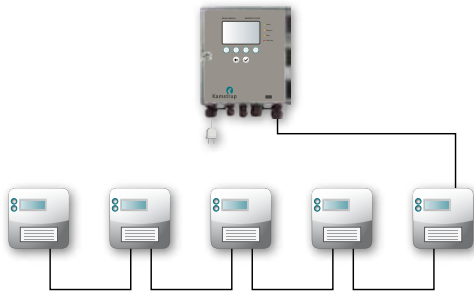

Bus topology with cable looped through meters

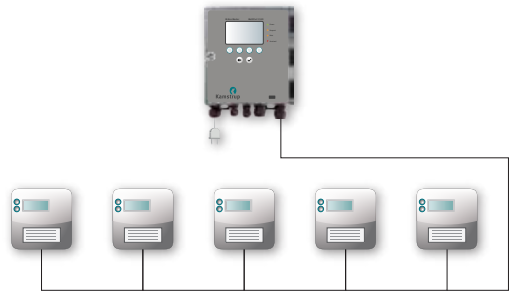

Bus topology with each individual meter connected to the bus

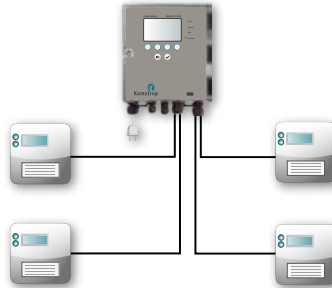

Star topology connecting each individual meter direct to the M-Bus Master

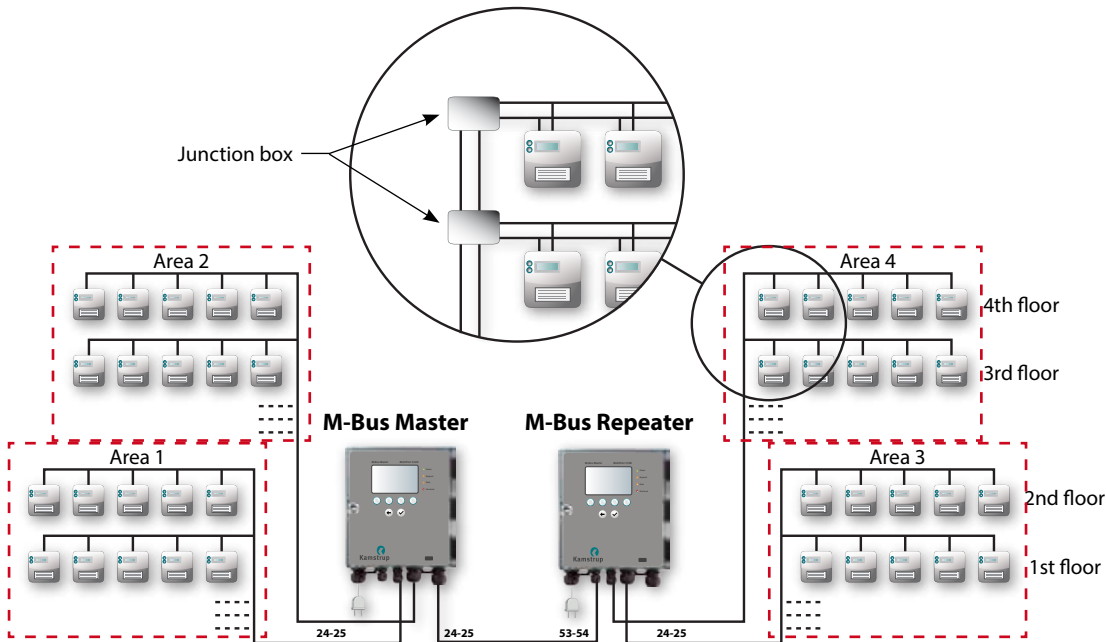

Example of the construction of a large M-Bus network.

Dividing the connected meters into several separate cable networks and connecting those individually to the Master will simplify troubleshooting.

4.3.3 Examples of network sizes

The below-mentioned tables show examples of possible network sizes with different cable configurations. Each connected repeater increases the possible cable length by the below-mentioned lengths.

Cable type 0.34 mm² (56 Ohm/110 nF)

Speed / Number of meters	10	50	150	250
300 Baud	10,000 m	2,000 m	700 m	400 m
2400 Baud	4,000 m	2,000 m	700 m	400 m
9600 Baud	2,000 m	2,000 m	700 m	400 m

Possible cable lengths with all meters placed at the end of the cable network

Speed / Number of meters	10	50	150	250
300 Baud	10,000 m	3,500 m	1,200 m	700 m
2400 Baud	7,000 m	3,500 m	1,200 m	700 m
9600 Baud	3,500 m	3,500 m	1,200 m	700 m

Possible cable lengths with meters evenly distributed in the cable network

Cable type 1.5 mm² (12 Ohm/110 nF)

Speed / Number of meters	10	50	150	250
300 Baud	10,000 m	8,000 m	2,800 m	1,600 m
2400 Baud	10,000 m	8,000 m	2,800 m	1,600 m
9600 Baud	3,500 m	3,500 m	2,800 m	1,600 m

Possible cable lengths with all meters placed at the end of the cable network

Speed / Number of meters	10	50	150	250
300 Baud	10,000 m	10,000 m	4,800 m	2,800 m
2400 Baud	10,000 m	10,000 m	4,800 m	2,800 m
9600 Baud	6,500 m	6,500 m	4,800 m	2,800 m

Possible cable lengths with meters evenly distributed in the cable network

5 M-Bus Addressing

Primary, secondary and enhanced secondary addressing are supported. The master's integrated collision detector enables wild card search for meters in connection with secondary and enhanced secondary addressing.

Using wild card search one or several of the digits of the meter's address are replaced by wild cards when searching for meters.

5.1 Primary addressing (001-250)

Each meter must have a unique primary address between 001 and 250. If more than one meter have the same address, a collision will occur and the meters cannot be read.

Kamstrup M-Bus modules automatically use the last 2-3 digits of the customer number as their primary address.

5.2 Secondary addressing (00000001-99999999)

Secondary addressing uses the last 8 digits of the meter number as M-Bus ID.

Kamstrup MULTICAL® meters use the customer number as their secondary address, which makes it possible to change the secondary address.

5.3 Enhanced secondary addressing (00000001-99999999)/(00000001-99999999)

The meter's serial number is used for enhanced secondary addressing. A meter's serial number is unique and cannot be changed after production.

6 M-Bus communication

M-Bus communication is half duplex allowing two-way communication with one M-Bus slave at a time.

The master's integrated port controller makes sure that communication is only possible on one serial port at a time.

6.1 Communication speed

M-Bus Master MultiPort 250D supports the following communication speeds:

- 300 Baud 8E1
- 2400 Baud 8E1
- 9600 Baud 8E1 (not via GPRS)

6.2 Transparent reading

MultiPort 250D is equipped with the following communication possibilities for reading from e.g. remote reading systems, control systems and various controllers with M-Bus interface:

- USB
- RS-232
- RS-485
- Optical eye
- GSM/GPRS (optional equipment)

Communication through the above-mentioned ports is transparent and includes collision detection.

7 Operation of M-Bus Master MultiPort 250D



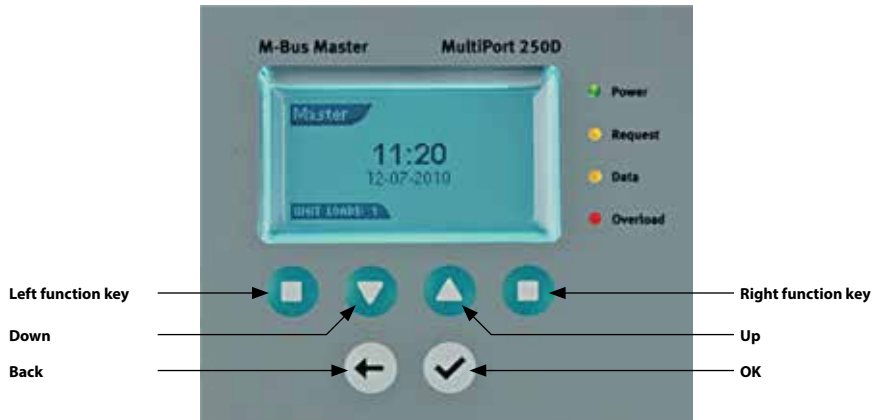



The master can be operated by means of its display and six keys.



7.1 Keys

According to the display structure the left and right function keys are soft keys, i.e. their function depends on the displayed menu point.

The six keys have the following functions:

Left function key  Typically page down or go left.	Right function key  Typically page up when viewing a list, shortcut when shortcut corner is shown, or go right when e.g. entering a value or setting date and time.
Down  Moves ► in the display downwards in the menu.	Up  Moves ► in the display upwards in the menu.
Back  Goes one level back (upwards) in the menu, or back to the previous screen if a shortcut key has been used.	OK  Starts the function which has been selected with the arrows keys, or saving a setting. Can also activate a function e.g. detailed view.

7.2 Light Emitting Diodes

The master has four light emitting diodes on its front plate.



7.2.1 Power

Green light emitting diode which is lit when the master is connected to supply power of 100-240 V, 50-60 Hz.

7.2.2 Request

Orange light emitting diode which flashes briefly when a command or a request from the master is transmitted to the M-Bus network.

7.2.3 Data

Orange light emitting diode which flashes when an M-Bus slave sends data to the master. The duration depends on the amount of data being sent.

7.2.4 Overload

Red light emitting diode which flashes when the load on the M-Bus network is between 375 and 500 mA. It is permanently lit when the load on the M-Bus network exceeds 500 mA. 375 mA corresponds to 250UL (M-Bus Unit Loads). At 500 mA M-Bus Master MultiPort 250D disconnects due to overload or short circuit condition.

7.3 Display

The resolution of the backlit display is 128x64 pixels. The master is operated by means of the display and the six keys. The four corners of the display are used for four different types of information.



Title

Displays the name of the menu, e.g. scan, or indicates whether the master is configured as master or as repeater.

Location

Shows where you are in a menu list, a meter list or a meter data list. Alternatively, it displays details of an ongoing function, e.g. secondary scanning at 2400 Baud.

Status

Indicates the status of the screen in question (refers to Title). For example it can indicate the number of slaves found during scanning.

Notifier

Displays information on a recent event. For instance it could be the number of a meter found during scanning. Notifier can also be a shortcut key, e.g. a meter reading can be started using the right-hand function key.

7.4 Menu overview



Status menu



Main menu

The top menu shows time and date, the configuration of the master as master or repeater, and the number of unit loads, with which the meters load the master. Typically the load of one meter is 1 unit load.

If PIN code protection is on, a padlock is displayed. The main menu shows the different menus available in the master.

7.5 Meter search by means of MultiPort 250D

Carrying out a meter search (scanning) by means of the master, you can choose primary or secondary scanning. Available communication speeds are 300, 2400 or 9600 Baud, and scanning can be carried out at all three speeds. It appears from the top of the master's display whether scanning has been effected with primary or secondary addressing, and also the selected speed is displayed. At the bottom of the display the number of meters found as well as the number of the last meter found is shown.

7.5.1 Primary scanning

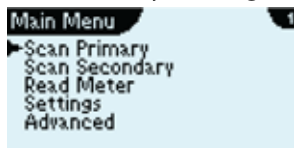

Select type of scanning

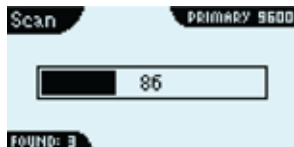

Primary scanning

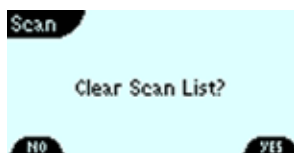

Re-scanning



Select speed



Scanning completed

Primary scanning scans for meters with M-Bus addresses between 001 and 250.

When performing an additional scanning, it is possible to keep the existing scanning list and add additionally found meters to the list.

7.5.2 Secondary scanning



Select type of scanning



Secondary scanning

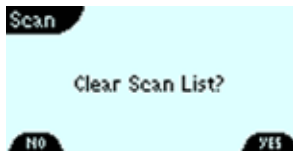

Re-scanning

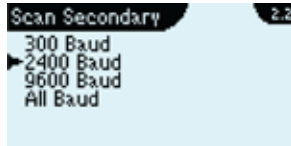

Select speed



Scanning completed

Secondary scanning scans for meters with M-Bus addresses between 00000000 and 99999999. Wildcard search is indicated by one or several digits of the meter number being replaced by "F".

OBS: During a secondary scanning, the Overload LED may flash if more than 20 meters reply to the master at the same time. This is quite normal during a secondary scanning.

When performing an additional scanning, it is possible to keep the existing scanning list and add additionally found meters to the list.

7.6 Meter reading by means of MultiPort 250D

Meter reading is effected either immediately after a scanning or from the menu Read Meter.

7.6.1 Meter reading after scanning



Meter list from scanning with sec. addr.



Meter list from scanning with prim. addr.

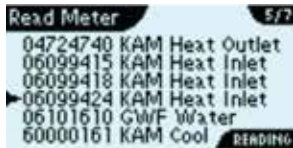

The meter is read

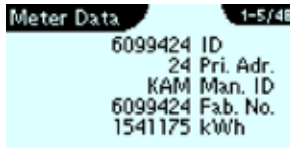

The meter has been read

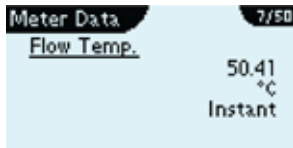

Detailed temperature indication

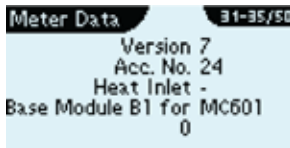

Detailed module type indication

7.6.2 Meter reading from the menu Read Meter



Main menu

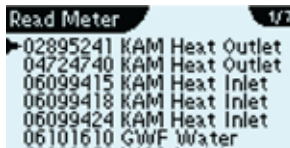

Meter reading

Scanning having been completed select Read Meter using the right function key to have the list of meters found displayed. Select the meter to be read using ▼ and ✓.

When the meter has been read the first data will appear in the display, which also indicates the total number of registers that can be read. The example to the left displays registers 1 to 5 of a total of 50 registers.

Scroll using ▼ and ▲.

Pressing ✓ again reading data is displayed in detailed resolution.

Reading MULTICAL® meters both M-Bus specific and manufacturer specific data are displayed by the master. Among other things software version and module type are displayed.

From other meter types M-Bus specific data is displayed.

M-Bus Master MultiPort 250D remembers the meters from the latest scanning. This means that it is not necessary to scan the whole M-Bus network every time a meter is to be read. You just select the meter to be read from the menu Read Meter and press ✓.

7.7 Settings of MultiPort 250D

A number of configurations can be set via the master's display.

All settings will be remembered, even if the master is without supply voltage.

Press ✓ to save the settings.

7.7.1 Date and time



The menu Settings

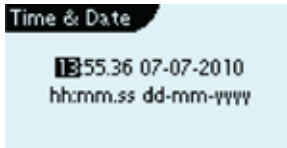

Adjustment of time and date

Adjust time and date using the keys. The value is changed using ▲ and ▼ and the left and right function keys are used for switching between the individual values.

7.7.2 Contrast

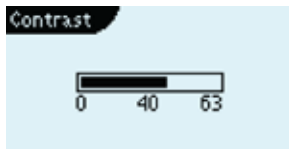

The contrast of the display can be adjusted for optimum reading.

7.7.3 M-Bus



NKE Delay

NKE Delay sets the master's delay after having sent a normalisation/initialisation to the meters in the network.

An initialisation has the effect that all modules are reset and collect new data from the meters.

Some module types require initialisation in order to be read. Other module types need a period of time after initialisation to prepare data for reading.

NKE Delay is per default Off, which means that NKE is not sent from the master.

Legacy Delay

If the master is connected to old generations of Kamstrup M-Bus modules and secondary addressing is used, Legacy Delay shall be min. 15 sec.

Legacy Delay ensures that the modules are ready to reply to the master when an NKE command is sent from the master.

Above is valid for the following M-Bus modules:

- 6604 and 6607 modules for MULTICAL® III
- 6608 and 6609 modules MULTICAL® 66CDE
- 6605 module for MULTICAL® Compact and MULTICAL® 401

Timing Profile

If no repeaters are connected to the master, the scanning speed can be set to Fast which improves the scanning speed during meter search.

Timing Delay



Baud Change Delay

Baud change delay sets how long the master must pause scanning when switching to another Baud rate in the menu Scan All Baud.

Baud Change Delay is per default 700 ms.

Bus Collision Delay

Bus Collision Delay sets how long the master must pause before continuing scanning after a collision between a number of M-Bus addresses.

Collision Delay is per default 700 ms.

Bus Overload Delay

Bus Overload Delay sets the delay of the internal scanner function after having detected an overload on the M-Bus outputs. This can e.g. be caused by too many connected meters or short-circuit in the cable network.

Overload Delay is per default 700 ms.

General Delay

General delay before all actions during M-Bus scanning.

General delay is per default 700 ms.

7.8 Green Mode

With the Green Mode function it is possible to switch off the power to all M-Bus slaves connected to the master. This reduces the electricity consumption of the M-Bus network by up to 15 Watt.

Power is automatically switched on again when communication is detected on one of the communication ports as well as when a front button is pressed.

If Green Mode is used in conjunction with a reading program, the program should be configured to send an initialization (SND_NKE) followed by a pause of one minute before reading is started with the M-Bus reading command (REQ_UD).

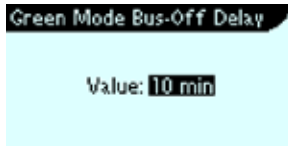
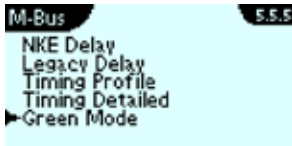

Green Mode Bus-off Delay sets the time the master waits to switch off the M-Bus power after last detected communication.

The Green Mode feature can be activated in masters with the serial number 48255589 or higher.

7.9 Other settings

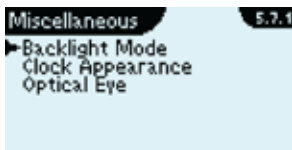

Backlight Mode

Select whether the display should be permanently lit or only when the master is operated.

Clock Appearance

Select analog or digital display.

Optical Eye

The optical eye can be activated and deactivated. If not in use, and when the master is placed in very light surroundings, the optical eye ought to be deactivated in order not to disturb communication on the other communication ports.

The optical eye is deactivated per default.

7.10 PIN code



Keyboard and reading via the optical eye of M-Bus Master MultiPort 250D can be protected by a PIN code.

The value is changed using ▲ and ▼ and the left and right function keys are used for switching between the individual digits. Press ✓ in order to activate the PIN code.

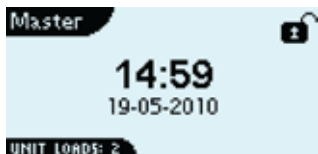

A padlock is displayed when the PIN code function is active. If the padlock is open the master is unlocked, the padlock is closed when the master is locked.

The master is automatically locked approx. 30 minutes after end of use.

Note: If the PIN code has been lost, the master can only be reset by a Kamstrup technician.

7.11 Advanced

The menu area Advanced includes various functions for meter reading, network troubleshooting, display of operation and error loggers etc.

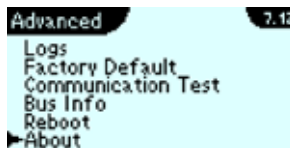
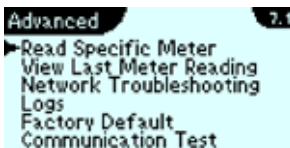
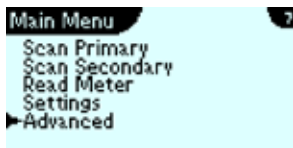

7.11.1 Reading a specific meter via the M-Bus address

Instead of scanning the whole network in order to read a single meter, the meter can be read by selecting its Baud rate, addressing form and M-Bus address via the function and arrow keys.

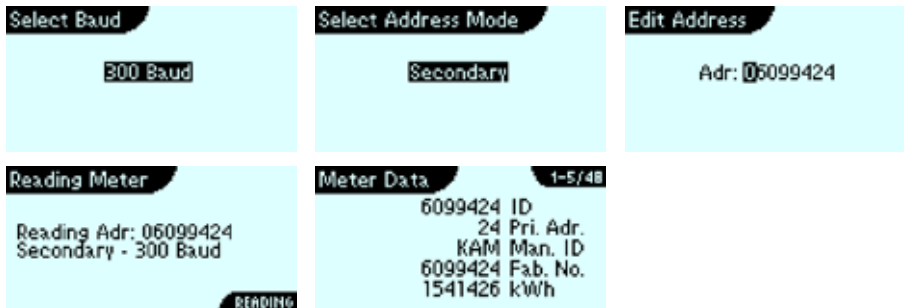

7.11.2 Reading a meter via secondary address

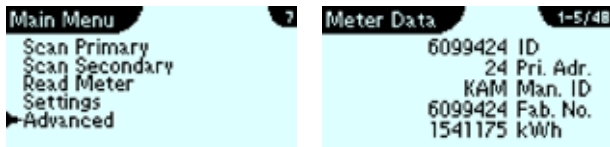

Instead of scanning the whole network in order to read a single meter, the meter can be read by selecting its M-Bus address.

Address and Baud rate are selected using the function and arrow keys.

7.11.3 Display latest meter reading

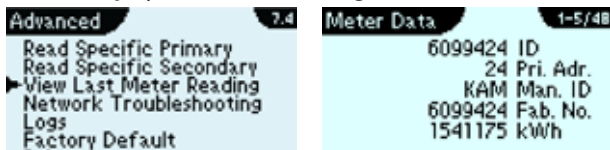

Data of the latest meter reading can be displayed by the master without reading the meter again.

7.11.4 Network troubleshooting

If an M-Bus network includes one or more masters which have been configured as repeaters, troubleshooting can be simplified by reconfiguring a repeater to master. Thereby you can scan the network from the selected master without reading the meters mounted before the master.

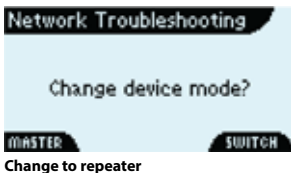
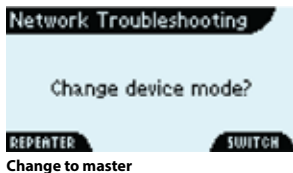

Communication from the master can be effected using keys and display as well as RS-232, USB and optical eye.

When the troubleshooting has been finished the operator must reconfigure to repeater using the keys or restarting the master.

7.11.5 Information loggers

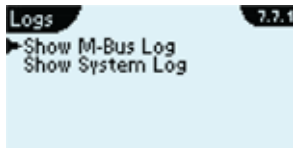

The M-Bus master has two loggers with information on previous events.

M-Bus logger



The M-Bus logger displays the latest scanings of the M-Bus network. Each event is time stamped by the master's built-in real time clock.

System logger



The system logger shows events in the master. Each event is time stamped by the master's built-in real time clock.

7.11.6 Factory settings

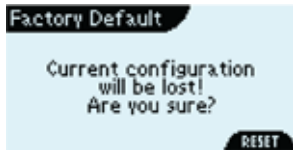

The master's settings can be restored to the default values it had when it was produced. Please note that loggers are reset too.

7.11.7 Communication Test

Communication test is used for testing communication between the master and a meter.

The test can be used with either primary or secondary addressing and one, more or all Baud rates. Setting is done via the function and arrow keys.

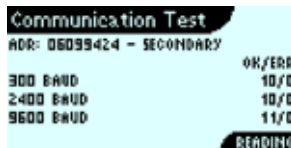
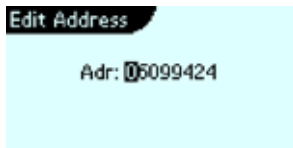
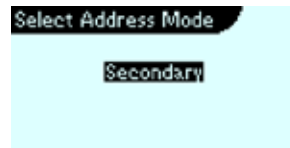
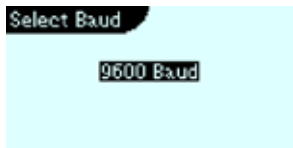

7.11.8 Bus Info

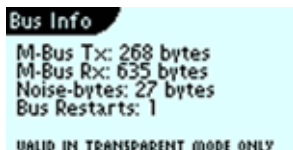

Bus Info shows information about the communication when the master is used as a repeater in transparent mode.

M-Bus Tx and M-Bus Rx show the amount of data to and from the master. The shown values are reset if the master is operated by means of the keys.

Noise-bytes show number of bytes received without any ongoing communication.

Performed scanning will be counted as noise.

Bus Restarts show how many times the master has restarted due to overload and short circuit conditions.

7.11.9 Restart master



Select Reboot Device



Master has been rebooted

If it is not possible to switch off the power supply, the master can be restarted by selecting the menu Reboot.

7.11.10 About M-Bus Master MultiPort 250D



The menu About displays the master's serial number as well as the individual hardware and software unit revisions.

8 Web Server

MultiPort 250D has a built-in web server for remote control and configuration.

The following programs can be used as PC-program:

- Microsoft® Internet Explorer version 8
- Mozilla Firefox 3
- Google Chrome 5

To be able to communicate with the master an IP for COM port converter must also be installed. The program can be collected on Kamstrup's homepages.

Communication can be effected via RS-232, RS-485 and USB.

The available options are described below.

8.1 IP->COM program

The program IP->COM Program¹ is downloaded from www.kamstrup.dk.

¹ The IP->COM Program is Freeware from Stephen Hill. Copyright © 2002. All Rights Reserved.

The screenshot shows the Kamstrup website with the following elements:

- Header:** Kamstrup logo with tagline "metering solutions" and the URL "www.thegreendifference.info". Navigation links include Home, Kamstrup world wide, Local websites, and a search bar.
- Secondary Navigation:** Products & solutions, Kamstrup AMR systems, Case stories, About us, Press room, Events & exhibitions, Contact us, Online services.
- Contact Kamstrup:**
 - Kamstrup A/S: Industrivej 28, Skilling, DK-8960 Skanderborg, Tel: (+45) 89 92 10 00, Fax: (+45) 89 92 10 02, info@kamstrup.dk
 - Kamstrup world wide: Includes a world map and a "Find us" button.
- Quickguide to products:**
 - Energy
 - Gas products
 - Water metering
 - Product services
 - Operations
 - Test & Calibration
- Open standard:**
 - New: Wireless M-Bus USB reader.
 - BTU Meter reading with wireless M-Bus: Simple and easy wireless reading of heat meters and cooling meters.
 - System output in 15 minutes
 - Readout time per meter: 3-5 seconds
 - The wireless M-Bus system from Kamstrup reads the combined heat and cooling meter MULTICH 402.
 - Wireless M-Bus Reader: MULTICH 402 - BTU meter
- Kamstrup AMR systems:**
 - Automatic reading, managing and billing of consumption data.
 - AMR solutions are easy to use, reliable and profitable and can be scaled and adjusted to match your requirements for functionality.
 - With a Kamstrup AMR system you always get a complete solution. Customised according to your needs and adapted to your operation and business. Supplied, installed and put into operation in one supply.
 - Read more...
- District Heating Firms:**
 - Public Heat Meter Readout for Garage Vias.
 - 80.000 heat meters are connected on a mobile radio network in Odense, Denmark.
 - The meters are being read automatically and wirelessly when the garbage is being collected.
 - All data for billing and grid optimisation are delivered on time, and what's more: the utility saves money and manpower.
 - Read the full story...
- Online services:**
 - On our website you can place orders, get web support for your PC programs and download documentation 24 hours/day.
 - System support
 - Downloads
 - Software
 - USB Meter Reader Software
 - Services in Bus Reader Software

Select Downloads from the menu area Online Services. Then select Software for M-Bus Master MultiPort250D and next IP->COM program.

Save the program file on your PC. Start the installer program and follow the installation instructions on the screen.

Start the program when the installation has been completed.

8.1.1 Configuration of IP->COM

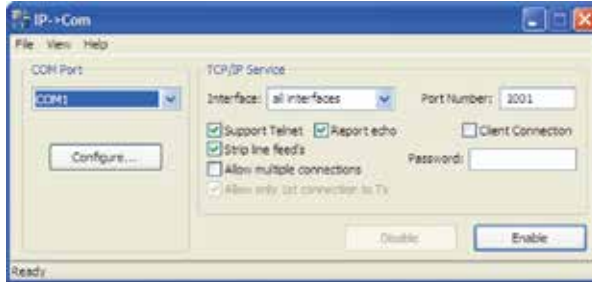

Standard start-up screen

Select the COM port, to which the master has been connected. Please note that a USB connection requires the selection of a COM port too. Select Configure.



Select 38400, 8, None, 1, None and click on Apply.

Alternatively, 9600, 8, None, 1, None, can be selected if the cable is very long.

Please note that the operation at 9600 is somewhat slower than at 38400.

In the menu TCP/IP Service, select Allow multiple connections and Allow only 1st connection to Tx. Support Telnet and Strip Line feeds must be empty.

Port number is automatically filled in.

Then select Enable.



When finished, Disable must be selected in order to release the COM port.

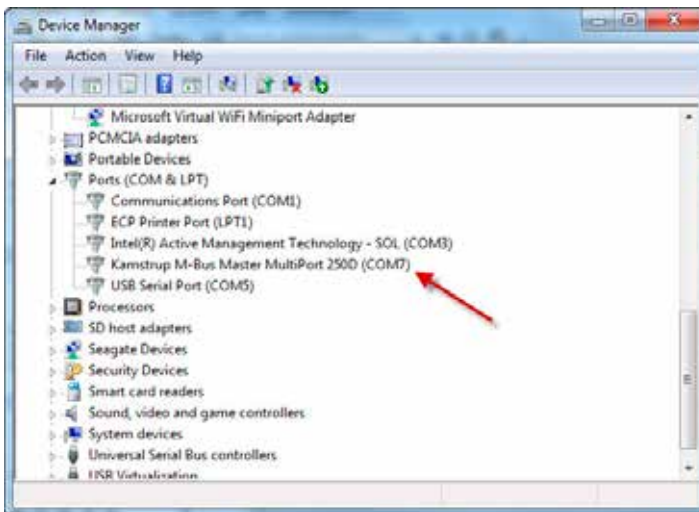

The selected COM port appears from Windows Device Manager.

Device Manager

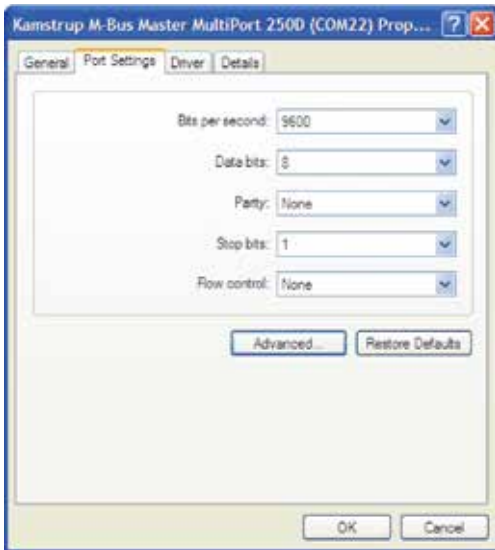

If you want to change the selected COM port, double-click on it in Device Manager. Under Port settings select Advanced and change to the required COM port.

Port settings

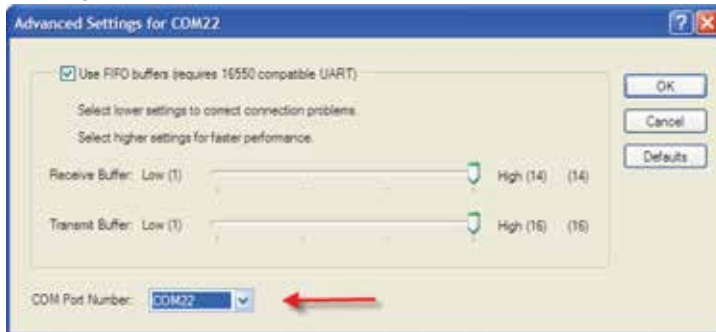

Port settings, advanced

8.2 Main menu

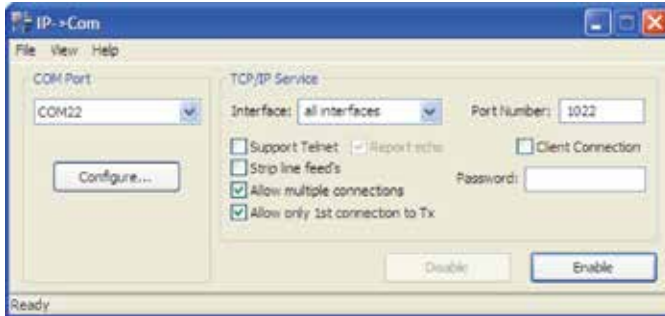

In order to access M-Bus Master MultiPort 250D start the browser and enter the following,
<http://localhost:xxxx>.

Replace xxxx by the Port Number of the program IP->COM. In the example 1022, of which 22 corresponds to the COM port, to which the master is connected.

Subsequently select the menu point you wish to apply.



8.3 Status menu

Displays various current status values for the master.

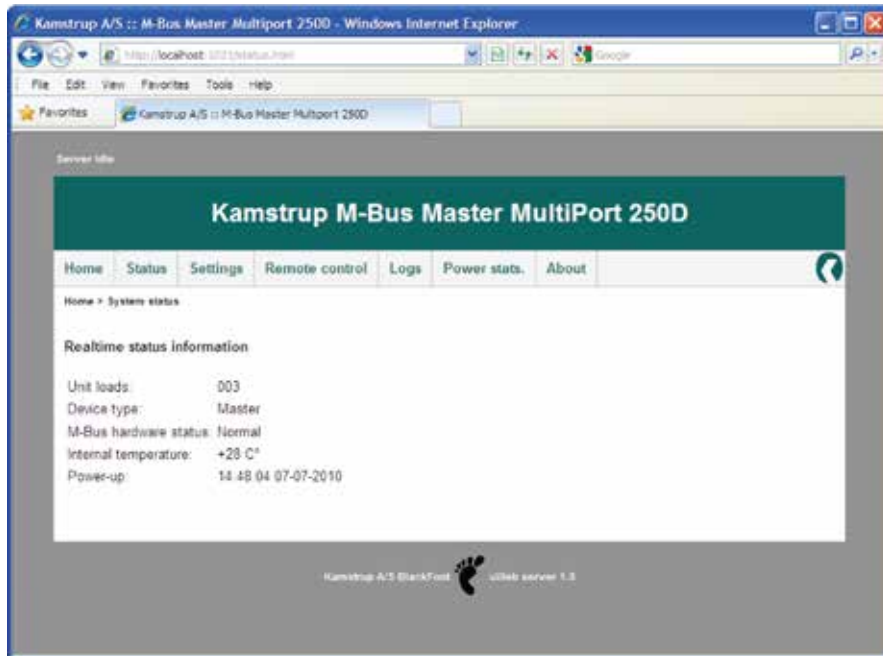

The screenshot shows a web browser window titled "Kamstrup A/S :: M-Bus Master Multiport 2500 - Windows Internet Explorer". The address bar shows "http://localhost:5022/status.html". The browser's menu bar includes "File", "Edit", "View", "Favorites", "Tools", and "Help". A Favorites bar is visible below the menu bar, containing a link to "Kamstrup A/S :: M-Bus Master Multiport 2500".

The main content area of the browser displays the "Server info" page for the "Kamstrup M-Bus Master MultiPort 250D". The page has a dark green header with the title "Kamstrup M-Bus Master MultiPort 250D" in white. Below the header is a navigation menu with tabs for "Home", "Status", "Settings", "Remote control", "Logs", "Power stats", and "About". The "Status" tab is currently selected.

Below the navigation menu, the breadcrumb "Home > System status" is shown. The main section is titled "Realtime status information" and contains the following data:

Unit loads:	003
Device type:	Master
M-Bus hardware status:	Normal
Internal temperature:	+20 C°
Power-up:	14 48 04 07-07-2010

At the bottom of the page, there is a footer that reads "Kamstrup A/S DanskFødt" followed by a logo of a footprint and the text "Web server 1.3".

8.4 Settings

Setting of date, time, PIN code etc.

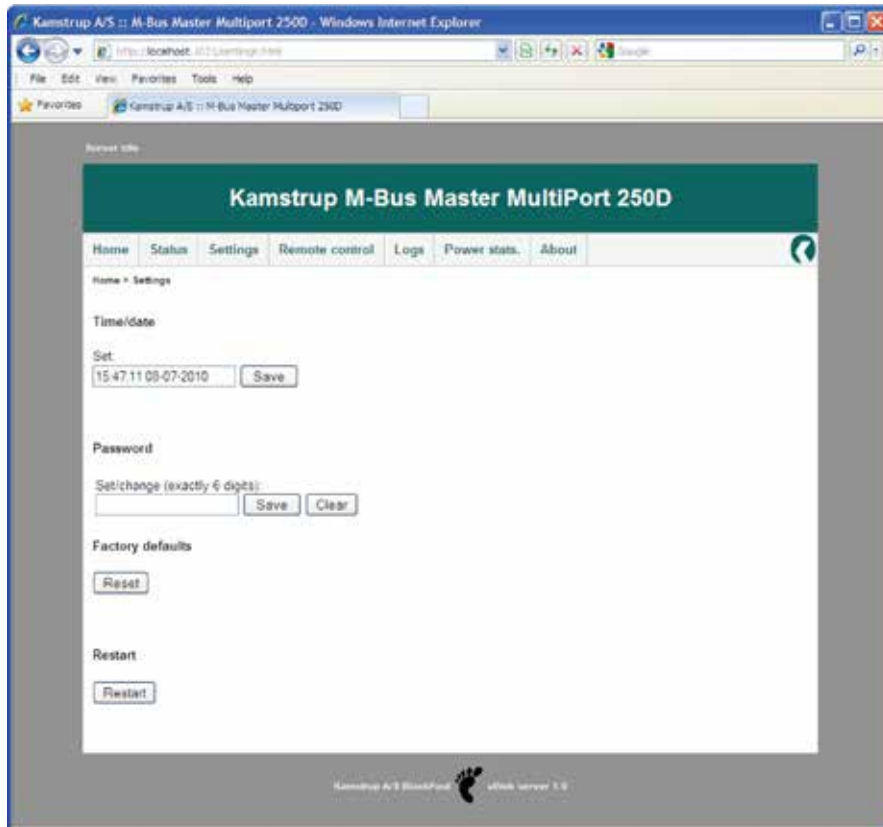

The screenshot shows a web browser window displaying the settings page for a Kamstrup M-Bus Master MultiPort 250D device. The browser's address bar shows the URL `http://localhost:802/Settings.html`. The page has a green header with the title "Kamstrup M-Bus Master MultiPort 250D" and a navigation menu with links for Home, Status, Settings, Remote control, Logs, Power stats, and About. The "Settings" link is selected. Below the navigation menu, the page is titled "Home > Settings". Under the "Time/date" section, there is a "Set:" label and a text input field containing "15:47:11 09-07-2010", with a "Save" button to its right. The "Password" section has a "Set/change (exactly 6 digits):" label and an empty text input field, with "Save" and "Clear" buttons to its right. The "Factory defaults" section contains a "Reset" button. The "Restart" section contains a "Restart" button. At the bottom of the page, there is a footer with the text "Kamstrup A/S BlackFoot" and "Web server 1.0" next to a logo.

8.5 Remote control

The master can be remotely controlled via its web server.



8.6 Event loggers

Displays an overview of registered events.

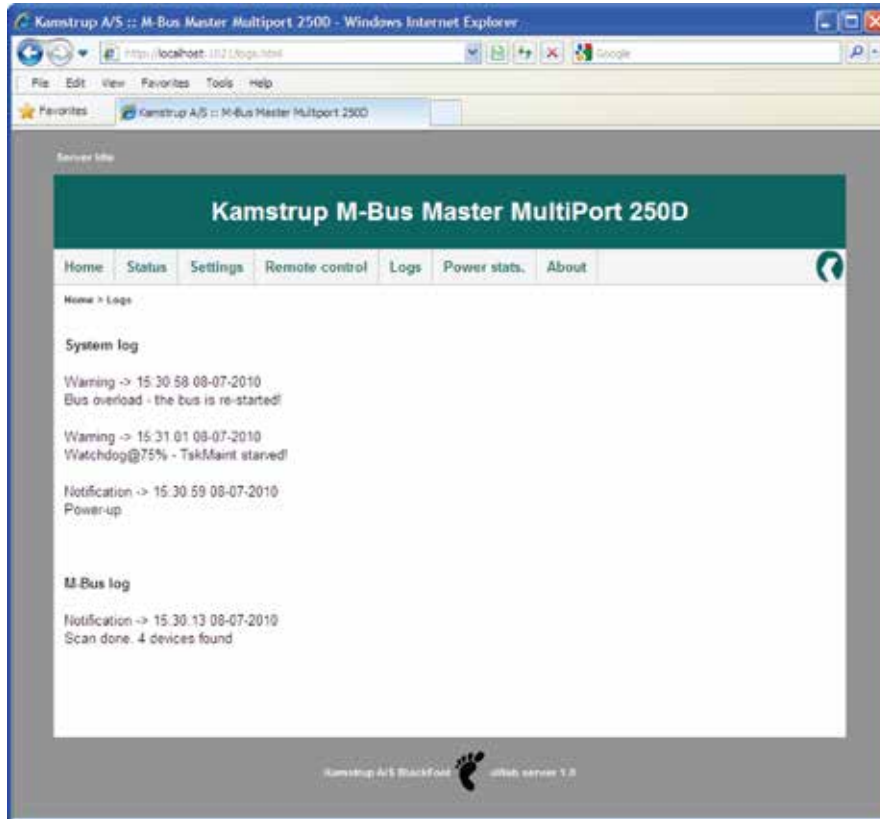

The screenshot shows a web browser window titled "Kamstrup A/S :: M-Bus Master Multiport 2500 - Windows Internet Explorer". The address bar shows "http://localhost:1121/logs.html". The page content includes a navigation menu with "Home", "Status", "Settings", "Remote control", "Logs", "Power stats", and "About". The "Logs" section is active, displaying a "System log" with the following entries:

- Warning -> 15:30:58 08-07-2010
Bus overload - the bus is re-started!
- Warning -> 15:31:01 08-07-2010
Watchdog@75% - TaskMaint starved!
- Notification -> 15:30:59 08-07-2010
Power-up

Below the system log is an "M-Bus log" section with one entry:

- Notification -> 15:30:13 08-07-2010
Scan done. 4 devices found

At the bottom of the page, there is a logo for "Kamstrup A/S BlackFoot" and the text "Web server 1.3".

8.7 Power statistics

Displays in an overview when the master has been switched on and off.

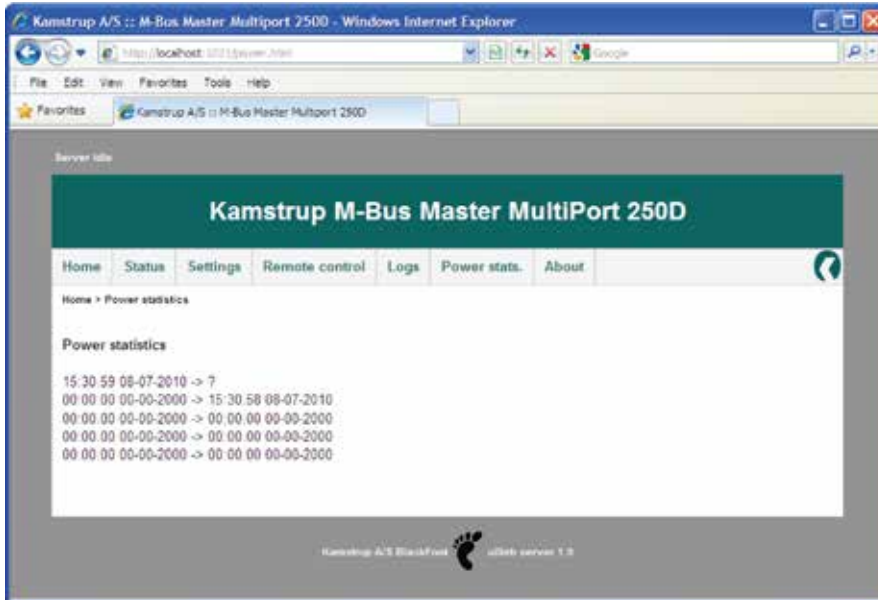

8.8 About M-Bus Master MultiPort 250D

Displays an overview of serial number, HW and SW versions.



The screenshot shows a Windows Internet Explorer browser window displaying the 'About' page of the Kamstrup M-Bus Master MultiPort 250D. The browser's address bar shows the URL 'http://localhost:1023/about.html'. The page has a green header with the title 'Kamstrup M-Bus Master MultiPort 250D' and a navigation menu with links for Home, Status, Settings, Remote control, Logs, Power stats, and About. The 'About' page content includes a section for 'Software/hardware revision information' with the following details:

Serial number:	00000001
Application rev.:	1.0
Bootloader rev.:	1.0
Software rev.:	A1
OS rev.:	6.0
Main board rev.:	1.0
Processor board rev.:	1.0

At the bottom of the page, there is a logo for 'Kamstrup A/S' and 'Web server 1.0'.

9 GSM/GPRS

M-Bus Master MultiPort 250D can be extended by a Kamstrup GSM 6H modem, enabling the master to be remotely read via GSM or GPRS. Reading via GPRS, the maximum M-Bus communication speed is 2400 Baud.

GSM 6H is mounted in the upper module area and is connected to the master's internal power supply as shown in the picture.

Electrical connection between the GSM 6H module and the M-Bus Master is established by means of a Jumper.

The external antenna must be connected as shown below and placed well away from the M-Bus master and the connected network wires.



SMS command

SIGNAL - for reading the signal strength	
Syntax, command	=SIGNAL#
Syntax, return answer	Signal: <signal strength> (0-31)
Example	=SIGNAL#
Return answer, correct	Signal: 14 (0-31)
Return answer, error	NO ANSWER

NOTE: SMS commands must be sent in either capital or small letters. Capital and small letters must not be mixed in the same SMS command.

As remote reading system we recommend Kamstrup PcBase III and PcNet III.

10 Dimensioned drawings

All measurements in mm.

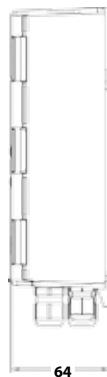
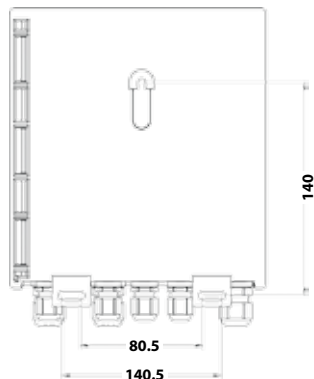
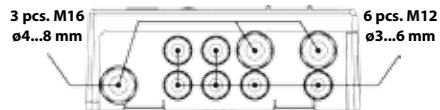
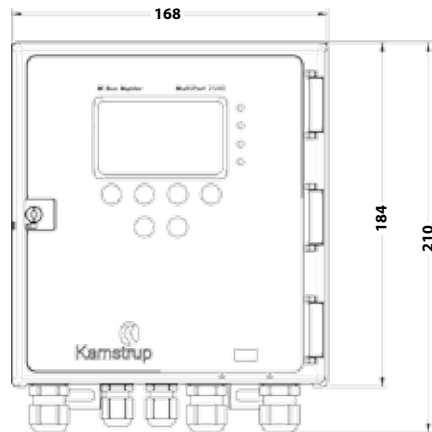

11 Technical data

Electrical (M-Bus)

Number of slaves per master	250 at 1 unit load per slave
Total number of slaves	1250 at 1 master and 4 repeaters
Cable length per master	Up to approx. 2800 m, depending on cable type, cable topology and number of connected slaves
Total cable length	Up to approx. 14 km at 1 master and 4 repeaters
Cable thickness	Max. 2 mm ²
Communication ports	RS-232, RS-485, USB, optical eye
Communication speeds	300/2400/9600 baud
Data frame	1 start bit, 8 data bits, 1 parity bit (even), 1 stop bit
Addressing modes, transparent	Primary/secondary/enhanced secondary
Addressing modes, direct reading	Primary/secondary
Address range, primary	001-250
Address range, secondary	00000000-99999999
Address range, enhanced secondary	00000000-99999999/00000000-99999999
Bus mark/space	41 V DC/28 V DC
Detection level, communication	7 mA
Detection level, collision	25 mA
Max. normal operating current	375 mA
Warning level, operating current	377 mA
Overload level	500 mA

Electrical (GSM 6H)

Frequencies	900-1800 MHz phase II+
Transmitting power 900 MHz Class 4	2 W
Transmitting power 1,800 MHz Class 1	1 W
GPRS classes	8, B
Communication speeds GSM	300/2400/9600 baud
Communication speeds GPRS	300/2400 baud

Electrical (HTTP)

Communication ports	RS-232, RS-485, USB
Communication speed	9600/38400 baud
Data frame	1 start bit, 8 data bits, no parity bit, 1 stop bit

Electrical (in general)

Power supply	100-240 V 50/60 Hz
Power consumption	Max. 40 W

Mechanical

Operating temperature range	0...55 °C, non-condensing, installation indoors
Storage temperature range	20...+60 °C
Protection class	Up to IP 67, depending on cables
Dimensions	210 x 168 x 64 mm (H x W x D)
Weight	1 kg

Approvals and standards

Approvals	CE marking
Standards	EN 13757-2, EN 13757-3

12 Ordering numbers

Description

M-Bus Master MultiPort 250D
M-Bus Master MultiPort 250D with GSM 6H
RS-232 cable DB 9, 145 cm
USB cable, 145 cm
GSM 6H incl. mini Triangle antenna with 1.5 m cable

Ordering No.

MBM-M210000
MBM-M210Z00
6699-335
6699-336
670XXXXX.MBM

