

M-Bus Master MultiPort 250L

Installation and User Guide



Kamstrup A/S
Industrivej 28, Stilling, DK-8660 Skanderborg
Tel: +45 89 93 10 00 · Fax: +45 89 93 10 01
info@kamstrup.com · www.kamstrup.com

Contents

1	Introduction	3	5	M-Bus Addressing	21
1.1	Design	3	5.1	Primary addressing	21
2	Functionality	4	5.2	Secondary addressing	21
2.1	Overview of functions	6	5.3	Enhanced secondary addressing	21
3	Connections	7	6	M-Bus communication	21
3.1	Overview of connections	8	6.1	Communication speed	21
3.2	Power supply	9	6.2	Transparent reading	22
3.3	USB	9	6.3	Light Emitting Diodes	22
3.4	RS-232	12	6.3.1	<i>Power</i>	22
3.5	RS-485	13	6.3.2	<i>Request</i>	22
3.6	M-Bus Output	13	6.3.3	<i>Data</i>	23
3.6.1	<i>Current and voltage</i>	13	6.3.4	<i>Overload</i>	23
3.7	M-Bus Repeater Input	14	7	GSM/GPRS	24
4	Cabling	15	8	Dimensioned drawings	25
4.1	Special features of M-Bus Master MultiPort 250L	15	9	Technical data	26
4.2	Electrical conditions in an M-Bus network	15	10	Ordering numbers	27
4.2.1	<i>M-Bus modules</i>	16			
4.3	Installation parameters	16			
4.3.1	<i>Cable</i>	16			
4.3.2	<i>Cable topology</i>	17			
4.3.3	<i>Examples of network sizes</i>	20			

1 Introduction

M-Bus is a bus system, which is specially suited for reading of water, heat, cooling, gas and electricity consumption meters. An M-Bus system consists of an M-Bus Master and a number of meters with M-Bus interface. A network can include different meter types and brands. The cable type used will typically be twisted pair copper.

The connected meters are read either directly by the master with data appearing on the master's display, or by a reading program which is connected to one of the master's communication ports.

The master powers the M-Bus slave modules in the meters. Battery supplied meters thereby achieve a longer battery lifetime.

The maximum size of an M-Bus network using Kamstrup M-Bus Master MultiPort 250L is 250 meters. If a number of masters are configured as repeaters and coupled in cascade and only secondary addressing is used, a total of 1,250 meters can be connected, and the total cable length can be up to approx. 14 km.

If primary addressing is used, up to 250 meters can be connected.

Communication in the M-Bus network is asynchronous serial bit transmission in half duplex, which means that it is only possible to communicate in one direction at a time.

Communication speed can be 300, 2400 or 9600 Baud.

It is not necessary to connect a PC to the master during installation, maintenance and troubleshooting in the M-Bus network as the master itself includes the functions needed. Operation is carried out via display and front keys.

M-Bus is standardized according to EN 13757-2 and EN 13757-3.

1.1 Design

M-Bus Master MultiPort 250L is built into a solid cabinet, which complies with protection class IP 67.

The power supply is a switch mode type which enables you to connect the master to a power supply between 100 and 240 Volt. The frequency must be 50-60 Hz.

2 Functionality

Kamstrup M-Bus Master MultiPort 250L is an M-Bus master designed for the connection of up to 250 meters with M-Bus interface. The cable length of a master can be up to 2800 m depending on cable type.

The master supports primary, secondary and enhanced secondary addressing.

All inputs are galvanically separated from the M-Bus network.

MultiPort 250L can be accessed from all available communication ports. The integral port controller prevents collision in case of simultaneous communication through more than one port.

When the port controller detects communication on one port, communication on other ports becomes impossible. When communication on one port is finished, all ports are open to communication.

The Repeater function makes it possible to extend the size of the M-Bus network both as to number of meters and total cable length. If one master and four repeaters are installed in a network, the total cable length can be extended to approx. 14 km and up to 1250 meters can be connected.

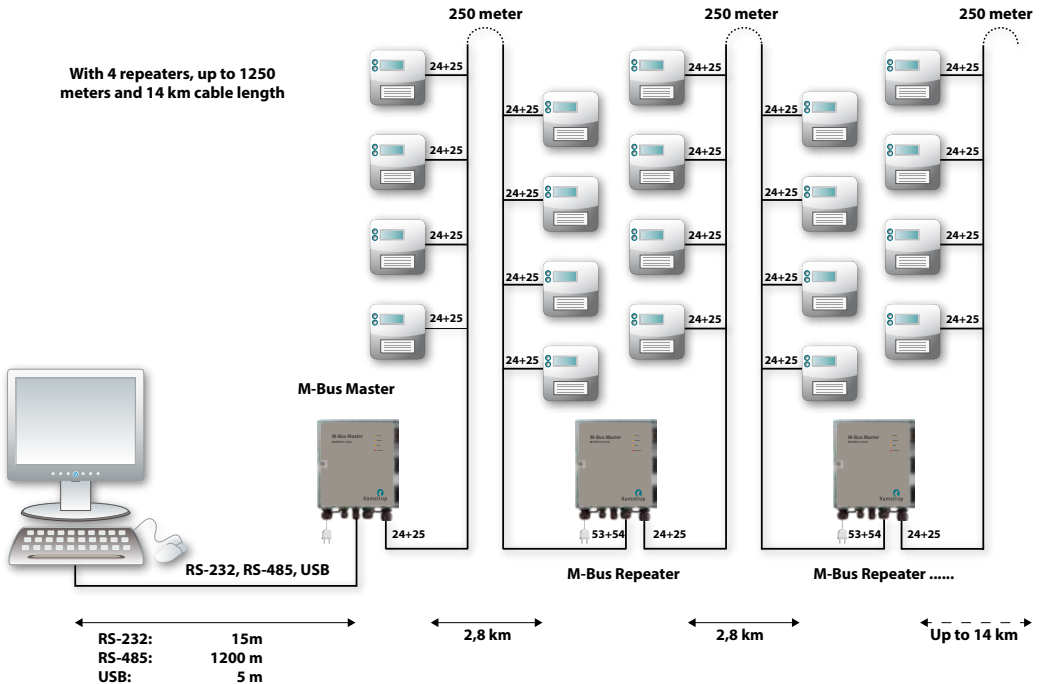

The master's module area provides extra communication options, e.g. GSM/GPRS, and also prepares the master for additional future functionalities.

Four light emitting diodes indicate the status of mains supply, data communication as well as possible overload and short-circuit of the M-Bus network.

Kamstrup M-Bus Master MultiPort 250L has been designed for installation indoors. The protection class can be up to IP 67.

2.1 Overview of functions

- Usable as transparent master, repeater and level converter
- Supports primary, secondary and enhanced secondary addressing
- Collision detection with break signal
- Up to 250 slaves per master
- Integrated repeater function
- Up to four repeaters in a system = a total of 1250 meters
- Up to 14 km cable length
- 300, 2400, and 9600 baud communication speed
- Byte recovery
- Echo suppression
- Transient protection
- Integrated USB, RS-232 and RS-485 with automatic port controller
- Module area for e.g. GSM/GPRS module
- All ports are transparent and galvanically separated from the M-Bus network
- Cable connection via 9 PG cable glands
- Local and remote update of firmware for future functionality
- Up to IP 67 protection class.

3 Connections

All connections in MultiPort 250L are screw terminals with max. cable size of 2 mm².

The protection class of M-Bus Master MultiPort 250L can be up to IP 67. IP 67 means full dust protection as well as water tightness for minimum 30 minutes down to 1 metre.

In order to obtain the highest IP protection the cables used must be correctly mounted through the master's unions.

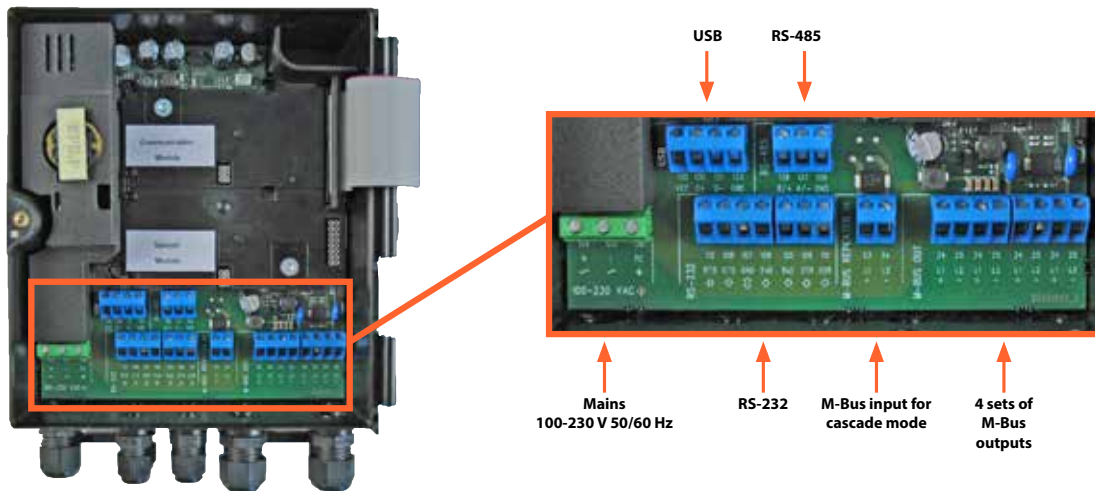

3.1 Overview of connections

Connection number on master	Designation	Colour/connector No.	Description
Power supply			
134	N	Blue	Neutral
135	L	Brown	Live
136	PE	Yellow/green	Protective earth
USB 2.0			
			Max. recommended cable length: 5 m
130	VCC	Red/1	5 V power supply
131	D-	White/2	Data -
132	D+	Green/3	Data +
133	GND	Black/4	Ground
RS-232			
			Max. recommended cable length: 15 m
105	RxD	2	Received Data
106	TxD	3	Transmitted Data
107	GND	5	Ground
108	DTR	4	Data Terminal Ready
109	CTS	8	Clear To Send
111	DSR	6	Data Set Ready
112	RTS	7	Request To Send
RS-485			
			Max. recommended cable length: 1,200 m
137	A/-		Transmit/Receive inverted
138	A+		Transmit/Receive non-inverted
139	GND		Ground
M-Bus Repeater Input			
			Jumper must be set to Repeater
53	L1		M-Bus input to master in repeater mode
54	L2		M-Bus input to master in repeater mode
M-Bus Master Output			
			4 sets connection terminals, connection in parallel
24	L1		M-Bus output from master to meters
25	L2		M-Bus output from master to meters

3.2 Power supply

The power supply of M-Bus Master MultiPort 250L is the switch mode type which requires voltage between 100 V and 240 V. The frequency can be 50 Hz or 60 Hz.

The mains cable is connected to the master through the associated gland. The diameter must be between 4 and 8 mm.

The master is supplied without mains cable and we recommend a fixed installation, i.e. without using a mains plug as this would reduce reliability of operation.

3.3 USB

M-Bus Master MultiPort 250L's USB-connection can be used for M-Bus communication on an equal basis with the other serial connections.

The following communication speeds can be used for M-Bus communication:

- 300 Baud 8E1
- 2400 Baud 8E1
- 9600 Baud 8E1

USB version 2.0, which allows up to 5 m cable length, is used. In connection with other USB versions than 2.0 the maximum cable length recommended is 3 m.

The master's integrated port controller makes sure that communication is only possible on one serial port at a time.

The master is available with a factory-mounted 145 cm cable fitted with a USB connector type A.



USB connector type A

To be able to communicate with M-Bus Master MultiPort 250L via USB the corresponding USB driver must be installed on the computer used for reading.

The program is available on Kamstrup's home page.

[Home](#) | [Kamstrup world wide](#) | [Local services](#) | [START SUBJECT MENU](#)





[Products & solutions](#) | [Kamstrup AMR systems](#) | [Case stories](#) | [About us](#) | [Press Room](#) | [Events & exhibitions](#) | [Contact us](#) | [Online services](#)

Contact Kamstrup

Kamstrup A/S
 Industrivej 28, Skilling
 DK-8550 Skanderborg
 Teli: (+45) 88 92 32 00
 Faksi: (+45) 88 92 32 01
info@kamstrup.dk

Kamstrup world wide



[Find us](#)

Quickguide to products

-  Meters
-  Gas products
-  Water heating
-  Product service
-  Operation
-  Test & Configuration

Here you will quickly and easily find documentation on Kamstrup's products and services.

Are you new to our homepage or would you like further information on our product range, or recommend pages click "Products" in the main menu...



Open standard

New



RTU Meter reading with wireless M-Bus

Simple and easy wireless reading of heat meters and cooling meters.

-  System setup in 15 minutes
-  Read-out time per meter: 3-2 seconds

The wireless M-Bus system from Kamstrup reads the combined heat and cooling meter MULTICAL 402.

Wireless M-Bus Reader
MULTICAL 402 - RTU meter

Kamstrup AMR systems



Kamstrup AMR - solutions for automatic reading, managing and billing of consumption data.

AMR solutions are easy to use, reliable and profitable and can be scaled and adjusted to match your requirements for functionality.

With a Kamstrup AMR system you always get a complete solution. Constructed according to your operation and adapted to your operation and business. Sourced, installed and put into operation by one supplier.

[Read more...](#)

District Heating Funnels



Mobile Heat Meter Readout - by Garbage Van

50,000 heat meters are connected in a mobile radio network in Copenhagen, Denmark. The meters are being read automatically and wirelessly when the garbage is being collected. All data for billing and grid optimisation are delivered on time, and what's more: the utility saves money and manpower.

[Read the full story...](#)

Online services



On our website you can place orders, get web support for your DC programs and download documentation 24 hours/day.

-  System support
-  Downloads
-  ELibrary
-  USB Meter Reader Software
-  Wireless M-Bus Reader Software

When selecting Run, the installation program starts automatically.
 When the program is retrieved, it is saved under C:\Kamstrup\M-Bus Master 250L.

Select as shown below in order to install the program.

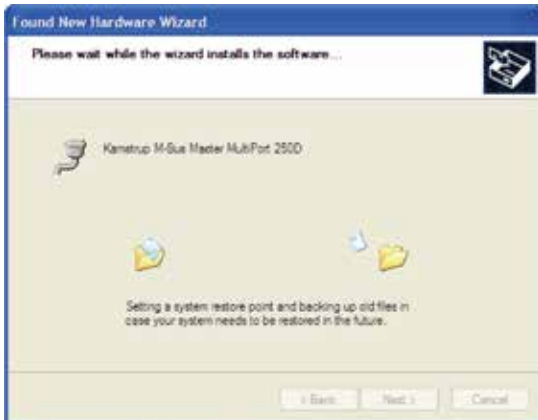
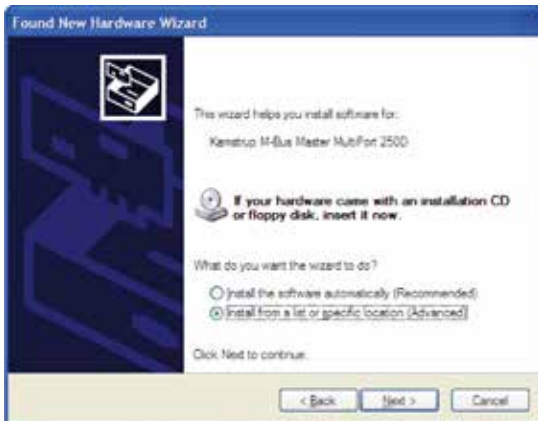



3.4 RS-232

M-Bus Master MultiPort 250L's RS-232-connection can be used for M-Bus communication on an equal basis with the other serial connections.

The following communication speeds can be used for M-Bus communication:

- 300 Baud 8E1
- 2400 Baud 8E1
- 9600 Baud 8E1

Maximum recommended cable length is 15 m.

The master's integrated port controller makes sure that communication is only possible on one serial port at a time.

The master is available with a factory-mounted 145 cm RS-232 cable fitted with a DB9F female connector.

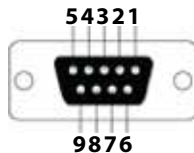

RS-232 connector type DB9F

3.5 RS-485

M-Bus Master MultiPort 250L's RS-485-connection can be used for M-Bus communication on an equal basis with the other serial connections.

The following communication speeds can be used for M-Bus communication:

- 300 Baud 8E1
- 2400 Baud 8E1
- 9600 Baud 8E1

Maximum recommended cable length is 1,200 m.

The master's integrated port controller makes sure that communication is only possible on one serial port at a time.

3.6 M-Bus Output

All meters in an M-Bus network are connected to M-Bus Output terminals 24 and 25. The master includes four sets of connections coupled in parallel.

3.6.1 Current and voltage

Bus mark/space	41 V DC/28 V DC	
Detection level, communication	7 mA	
Detection level, collision	25 mA	
Max. normal operating current	375 mA	
Warning level, operating current	377 mA	- Overload LED flashes
Overload level, operating current	500 mA	- Overload LED is constantly illuminated

3.7 M-Bus Repeater Input

Kamstrup M-Bus Master MultiPort 250L can be used as both master and repeater. Used as master, up to 250 meters can be connected in an M-Bus system.

The Repeater function makes it possible to extend the size of the M-Bus network both as to number of meters and total cable length. If one master and four repeaters are installed in a network, the total cable length can be extended to approx. 14 km, and up to 1250 meters can be connected.

The master is configured as repeater by placing the jumper on the connector marked Repeater. Using an M-Bus Master MultiPort 250L as a repeater the M-Bus network in front of the repeater is connected to "M-Bus Repeater In" on terminals 53 and 54. The following meters are connected to M-Bus Out on terminals 24 and 25.



Position of master/repeater jumper

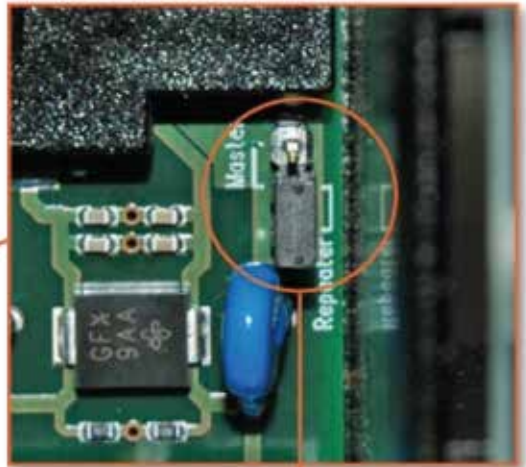

Setting as master or repeater

4 Cabling

Typically unshielded twisted pair cable up to approx. 1.5 mm² is used. The cabling topology is typically star or bus or a combination of both. The connection in M-Bus is independent of polarity and no termination resistance at the end of the cabling is needed.

If a cable type with shield is used, it is important that the two M-Bus conductors are not connected to ground or shield. No precise indication as to maximum cable length in an M-Bus network can be given as it depends on various parameters. The two most important parameters to consider when selecting cable for an M-Bus installation are cable resistance and cable capacity. Generally speaking the resistance limits the number of M-Bus slaves, and the capacity limits the communication speed.

Furthermore, we recommend keeping a certain distance between M-Bus cables and other cables in order to minimize noise from high-power electric machinery.

4.1 Special features of M-Bus Master MultiPort 250L

M-Bus Master MultiPort 250L has been designed with the newest cable driver technology, and is, therefore, rather insensitive to the capacity of the M-Bus network.

Thus, designing an M-Bus network to be used together with M-Bus Master MultiPort 250L the limiting factor as to possible cable length will primarily be the cable resistance in the network.

4.2 Electrical conditions in an M-Bus network

According to EN 13757-2, the maximum output voltage from an M-Bus Master must not exceed 42 V. The output voltage from M-Bus Master MultiPort 250L is 41 V.

- If the voltage measured over terminals 24-25 is 24 V or more at the most distant meter, there is a high degree of certainty that all meters can be read
- If the voltage is between 20 and 24 V, it will probably be possible to read all meters
- If the voltage is between 18 and 20 V, the meter may be read
- If the voltage is below 18 V it is most likely that the meter cannot be read

There must be no communication on the M-Bus network when the above measurement is made.

4.2.1 M-Bus modules

Each M-Bus module loads the M-Bus network too. According to the standard, an M-Bus module should load the network with 1 unit load (UL) corresponding to 1.5 mA. Some modules, however, load with up to 4 UL.

Capacitively the load of an M-Bus module is 0.5 – 1 nF.

The number of connected M-Bus slaves is shown on the display of M-Bus Master 250L. Please note that it is not possible to show the exact number of connected slaves. This is due to tolerances in the slaves.

4.3 Installation parameters

The following parameters are essential to the possible cable length of an M-Bus network.

4.3.1 Cable

The cable resistance and capacity must be as low as possible. The thicker the cable, the lower the resistance. The thicker the cable, the higher the capacity.

An M-Bus cable must minimum be able to handle 50 V and 500 mA.

Diameter (mm ø)	Cross section (mm ²)	Resistance in Ohm per 1,000 metres	Length in metres per Ohm
0.5	0.20	90	11
0.65	0.33	53	19
0.8	0.50	35	29
1.0	0.79	23	45
1.13	1.00	18	57
1.26	1.25	14	71
1.39	1.52	12	87
1.6	2.0	8.7	115

Examples of resistance in copper cable

Please note that the resistance in copper depends on its purity. The purer the copper, the lower its resistance.

LiYY	2x0.34 mm ²	2x0.50 mm ²	2x0.75 mm ²	2x1.0 mm ²	2x1.5 mm ²
Current load	Max. 4.5 A	Max. 6 A	Max. 10 A	Max. 12 A	Max. 18 A
Cable resistance	56 Ω/km	39 Ω/km	26 Ω/km	20 Ω/km	12 Ω/km
Capacity	110 nF/km	120 nF/km	120 nF/km	120 nF/km	120 nF/km

J-Y(St)YY	2x0.60 mm ²	2x0.80 mm ²		
Current load	-	-		
Cable resistance	65 Ω/km	37 Ω/km		
Capacity	120 nF/km	100 nF/km		

Examples of cable types

In big networks using secondary addressing worst case load must be considered as 250 slaves of 1 UL (Unit Load) each can draw 5.4 A, which thin cables will not be able to withstand.

Please note that resistance can be stated in two different ways in cable specifications; i.e. as cable resistance or as loop resistance.

Loop resistance is the total resistance measured through the two conductors. Cable resistance is the resistance through one conductor. Therefore, loop resistance is always twice the cable resistance.

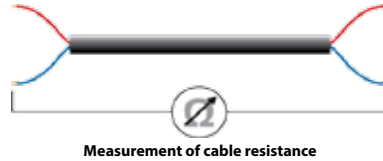

4.3.2 Cable topology

An M-Bus network normally uses bus or star topology, or a combination of both.

The advantage of bus topology is shorter wires. The disadvantage is that a cable interrupt will mean that all the following meters can no longer be read.

The advantage of star topology is the fact that all the other meters can still be read after a cable interrupt. The disadvantage is a large consumption of cable with a high leading load, which reduces the maximum cable length and makes a reduction of communication speed necessary respectively.

Bus topology offers two solutions, one looping the cable through each meter. This solution presupposes that there is room for two cables and that the connection terminals are prepared for the connection of two sets of cables. All connections are thereby typically made inside the meter.

Using bus topology with each individual meter connected to the bus, a number of connections must be established on the bus itself.

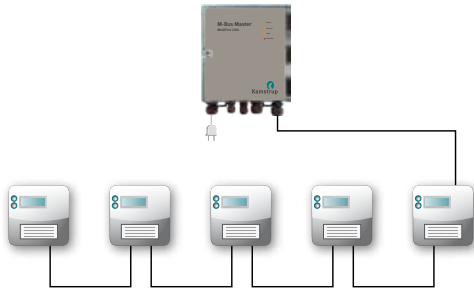

Bus topology with cable looped through meters

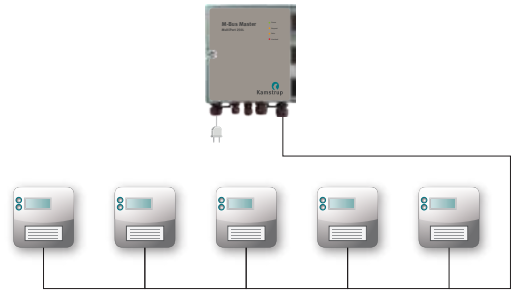

Bus topology with each individual meter connected to the bus

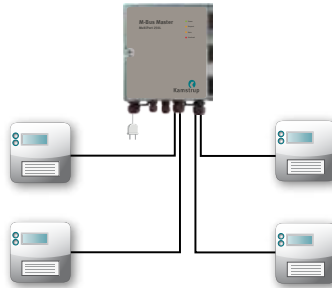

Star topology connecting each individual meter direct to the M-Bus Master

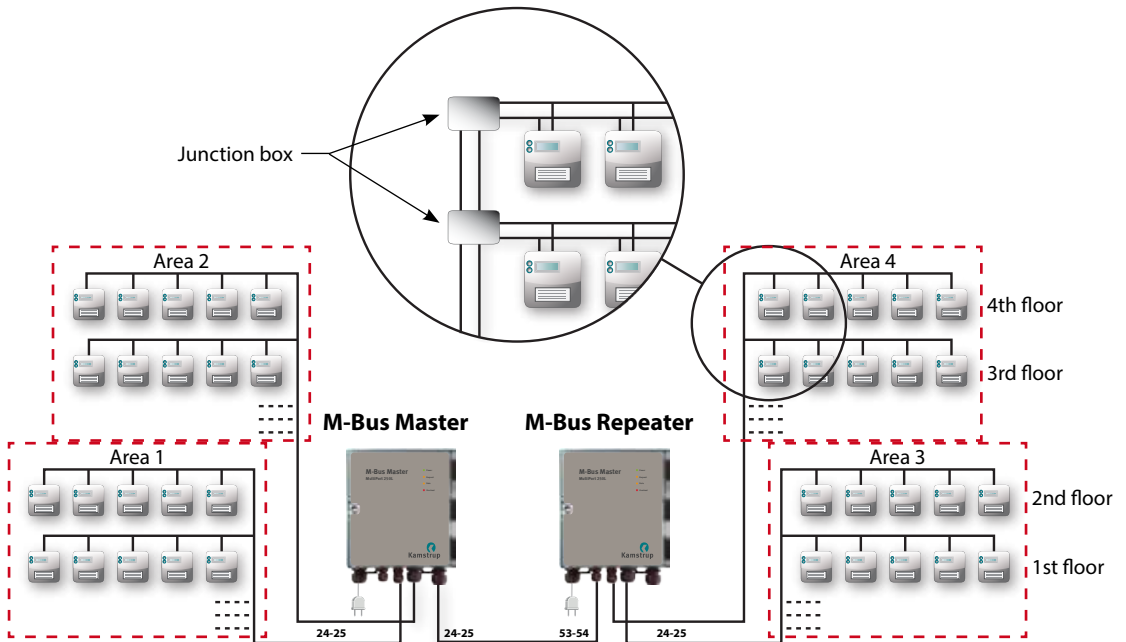

Example of the construction of a large M-Bus network.

Dividing the connected meters into several separate cable networks and connecting those individually to the Master will simplify troubleshooting.

4.3.3 Examples of network sizes

The below-mentioned tables show examples of possible network sizes with different cable configurations. Each connected repeater increases the possible cable length by the below-mentioned lengths.

Cable type 0.34 mm² (56 Ohm/110 nF)

Speed / Number of meters	10	50	150	250
300 Baud	10,000 m	2,000 m	700 m	400 m
2400 Baud	4,000 m	2,000 m	700 m	400 m
9600 Baud	2,000 m	2,000 m	700 m	400 m

Possible cable lengths with all meters placed at the end of the cable network

Speed / Number of meters	10	50	150	250
300 Baud	10,000 m	3,500 m	1,200 m	700 m
2400 Baud	7,000 m	3,500 m	1,200 m	700 m
9600 Baud	3,500 m	3,500 m	1,200 m	700 m

Possible cable lengths with meters evenly distributed in the cable network

Cable type 1.5 mm² (12 Ohm/110 nF)

Speed / Number of meters	10	50	150	250
300 Baud	10,000 m	8,000 m	2,800 m	1,600 m
2400 Baud	10,000 m	8,000 m	2,800 m	1,600 m
9600 Baud	3,500 m	3,500 m	2,800 m	1,600 m

Possible cable lengths with all meters placed at the end of the cable network

Speed / Number of meters	10	50	150	250
300 Baud	10,000 m	10,000 m	4,800 m	2,800 m
2400 Baud	10,000 m	10,000 m	4,800 m	2,800 m
9600 Baud	6,500 m	6,500 m	4,800 m	2,800 m

Possible cable lengths with meters evenly distributed in the cable network

5 M-Bus Addressing

Primary, secondary and enhanced secondary addressing are supported. The master's integrated collision detector enables wild card search for meters in connection with secondary and enhanced secondary addressing.

Using wild card search one or several of the digits of the meter's address are replaced by wild cards when searching for meters.

5.1 Primary addressing (001-250)

Each meter must have a unique primary address between 001 and 250. If more than one meter have the same address, a collision will occur and the meters cannot be read.

Kamstrup M-Bus modules automatically use the last 2-3 digits of the customer number as their primary address.

5.2 Secondary addressing (0000001-9999999)

Secondary addressing uses the last 8 digits of the meter number as M-Bus ID.

Kamstrup MULTICAL® meters use the customer number as their secondary address, which makes it possible to change the secondary address.

5.3 Enhanced secondary addressing (0000001-9999999)/(0000001-9999999)

The meter's serial number is used for enhanced secondary addressing. A meter's serial number is unique and cannot be changed after production.

6 M-Bus communication

M-Bus communication is half duplex allowing two-way communication with one M-Bus slave at a time.

The master's integrated port controller makes sure that communication is only possible on one serial port at a time.

6.1 Communication speed

M-Bus Master MultiPort 250L supports the following communication speeds:

- 300 Baud 8E1
- 2400 Baud 8E1
- 9600 Baud 8E1 (not via GPRS)

6.2 Transparent reading

MultiPort 250L is equipped with the following communication possibilities for reading from e.g. remote reading systems, control systems and various controllers with M-Bus interface:

- USB
- RS-232
- RS-485
- GSM/GPRS (optional equipment)

Communication through the above-mentioned ports is transparent and includes collision detection.

6.3 Light Emitting Diodes

The master has four light emitting diodes on its front plate.

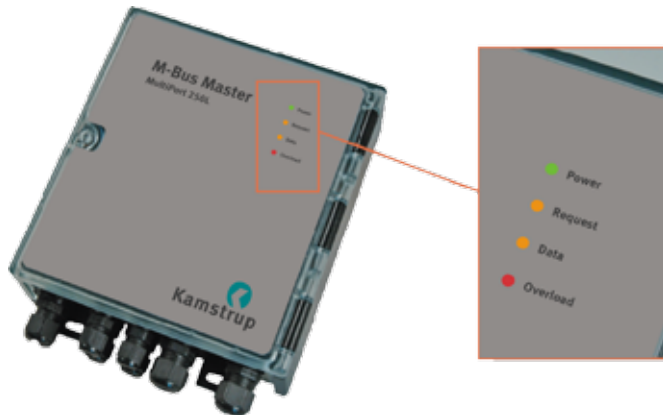

6.3.1 Power

Green light emitting diode which is lit when the master is connected to supply power of 100-240 V, 50-60 Hz.

6.3.2 Request

Orange light emitting diode which flashes briefly when a command or a request from the master is transmitted to the M-Bus network.

6.3.3 Data

Orange light emitting diode which flashes when an M-Bus slave sends data to the master. The duration depends on the amount of data being sent.

6.3.4 Overload

Red light emitting diode which flashes when the load on the M-Bus network is between 375 and 500 mA. It is permanently lit when the load on the M-Bus network exceeds 500 mA. 375 mA corresponds to 250UL (M-Bus Unit Loads). At 500 mA M-Bus Master MultiPort 250L disconnects due to overload or short circuit condition.

7 GSM/GPRS

M-Bus Master MultiPort 250L can be extended by a Kamstrup GSM 6H/8H modem, enabling the master to be remotely read via GSM or GPRS. Reading via GPRS, the maximum M-Bus communication speed is 2400 Baud.

GSM 6H/8H is mounted in the upper module area and is connected to the master's internal power supply as shown in the picture.

Electrical connection between the GSM 6H/8H module and the M-Bus Master is established by means of a Jumper.

The external antenna must be connected as shown below and placed well away from the M-Bus master and the connected network wires.



SMS command

SIGNAL - for reading the signal strength	
Syntax, command	=SIGNAL#
Syntax, return answer	Signal: <signal strength> (0-31)
Example	=SIGNAL#
Return answer, correct	Signal: 14 (0-31)
Return answer, error	NO ANSWER

NOTE: SMS commands must be sent in either capital or small letters. Capital and small letters must not be mixed in the same SMS command.

As remote reading system we recommend Kamstrup PcBase III and PcNet III or USB Meter Reader.

8 Dimensioned drawings

All measurements in mm.

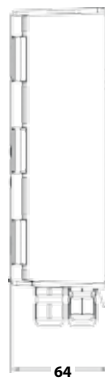
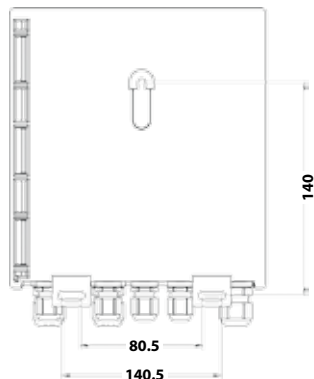
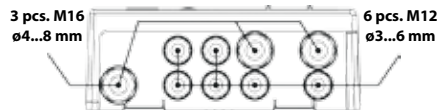
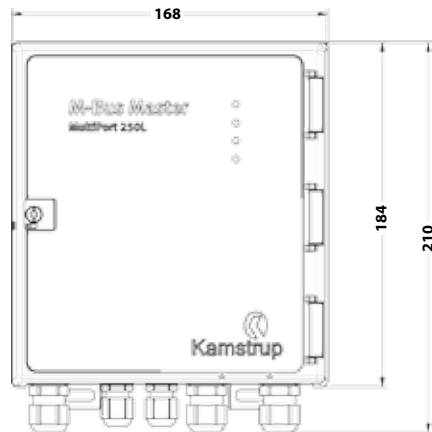

9 Technical data

Electrical (M-Bus)

Number of slaves per master	250 at 1 unit load per slave
Total number of slaves	1250 at 1 master and 4 repeaters
Cable length per master	Up to approx. 2800 m, depending on cable type, cable topology and number of connected slaves
Total cable length	Up to approx. 14 km at 1 master and 4 repeaters
Cable thickness	Max. 2 mm ²
Communication ports	RS-232, RS-485, USB
Communication speeds	300/2400/9600 baud
Data frame	1 start bit, 8 data bits, 1 parity bit (even), 1 stop bit
Addressing modes, transparent	Primary/secondary/enhanced secondary
Addressing modes, direct reading	Primary/secondary
Address range, primary	001-250
Address range, secondary	00000000-99999999
Address range, enhanced secondary	00000000-99999999/00000000-99999999
Bus mark/space	41 V DC/28 V DC
Detection level, communication	7 mA
Detection level, collision	25 mA
Max. normal operating current	375 mA
Warning level, operating current	377 mA
Overload level	500 mA

Electrical (in general)

Power supply	100-240 V 50/60 Hz
Power consumption	Max. 40 W

Mechanical

Operating temperature range	0...55 °C, non-condensing, installation indoors
Storage temperature range	20...+60 °C
Protection class	Up to IP 67, depending on cables
Dimensions	210 x 168 x 64 mm (H x W x D)
Weight	1 kg

Approvals and standards

Approvals	CE marking
Standards	EN 13757-2, EN 13757-3

10 Ordering numbers

Description

M-Bus Master MultiPort 250L
RS-232 cable DB 9, 145 cm
USB cable, 145 cm

Ordering No.

MBM-M200000
6699-335
6699-336

